



GstarCAD Architecture 2016

User Guide

Table of Contents

1.	Preface	1
2.	Installation	1
3.	Startup and Interface	2
1.1.	Startup	2
1.2.	Interface Introduction	3
4.	Design and Operation	3
5.	Case Study	4
1.3.	Draw grids in plan drawing	4
1.4.	Grid Dimension in plan drawing	5
1.5.	Draw walls in plan drawing	7
1.6.	Draw columns in plan drawing	9
1.7.	Draw win-door in plan drawing	11
1.8.	Draw corner windows in plan drawing	13
1.9.	Draw U-shaped stair in plan drawing	14
1.10.	Draw steps in plan drawing	15
1.11.	Draw apron in plan drawing	16
1.12.	Draw balcony in plan drawing	17
1.13.	Draw roofs in plan drawing	19
1.14.	Linear Dimension	20
1.15.	Subjoin Dimension	21
1.16.	Bay Combine	22
1.17.	Remove Dimension	23
1.18.	Room Label	24
1.19.	Elevation Dimension	25
1.20.	Section Symbols Dimension	26
1.21.	Index Symbol Dimension	27
1.22.	Title Index Dimension	29
1.23.	Title Mark	29
1.24.	Viewport Symbol	30
1.25.	Compass	30
1.26.	Stage exercise Summary and Drawing Process	31
1.27.	Project Management	31
1.28.	Generate Elevations by Project Management	35
1.29.	Generate Section by Project Management	36
1.30.	Generate 3D model by Project Management	38
1.31.	Summary	40

1. Preface

Hello! This document will help you learn key features of GstarCAD Architecture. We will introduce GstarCAD Architecture in the following order: Installation -> Startup and Interface -> Design and Operation -> Case Study. You could access www.gstarcad.net for more information.

2. Installation

Download installation program from company website:

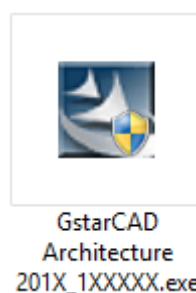

Fig 1. Run the installation file

Double click to run the installation program and enter installation interface. Check "I accept ..." option and click "Next" button as shown in figure 2.

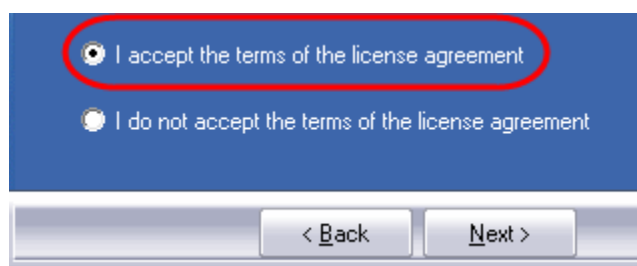

Fig 2. Accept the agreement

Check which function you need to install. It is recommended to accept all (install all functions by default). Destination Folder is used to specify installation directory. You could change installation directory by clicking "Browse" button.

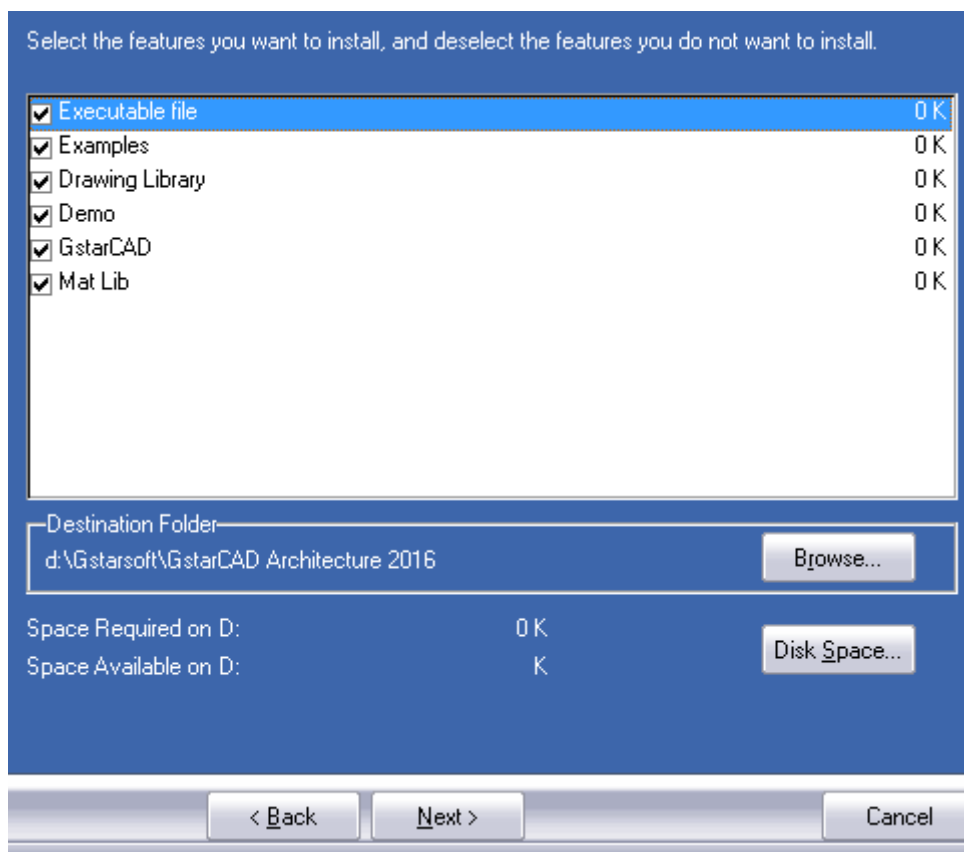

Fig 3. Select which function to install

After selected functions and installation directory, click "Next" button to next step. In the following page, it prompts to select program folder, you could directly click "Next" button. It may take you several minutes to finish installation; and then click "Finish" button to exit. You could find program icon on the desktop and in startup menu.

3. Startup and Interface

3.1.Startup

Double click GstarCAD Architecture icon  and enter startup interface.

In the following interface, you could select Activate or Try. If you have purchased a license, you could click "Activate" button; otherwise you could click Try to use in the trial period. And then, it displays startup interface.

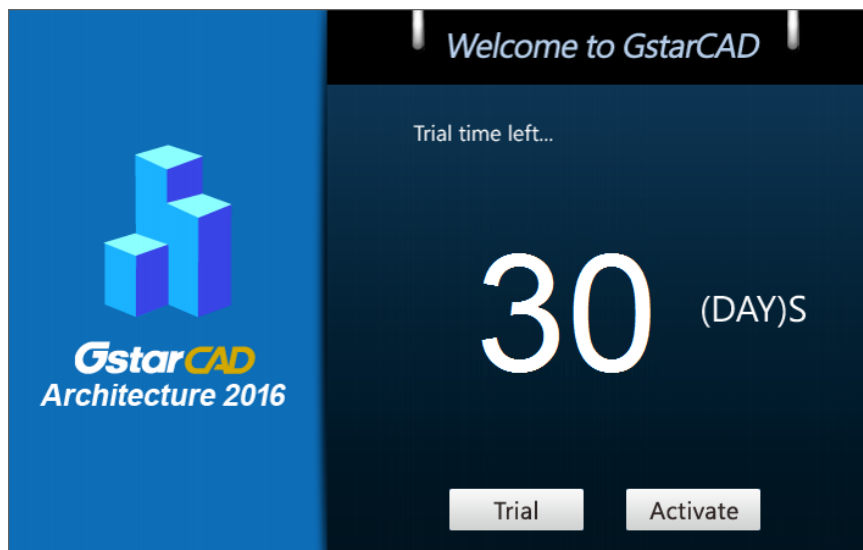

Fig 4. Activate or Try

3.2. Interface Introduction

GstarCAD Architecture interface is shown as below:

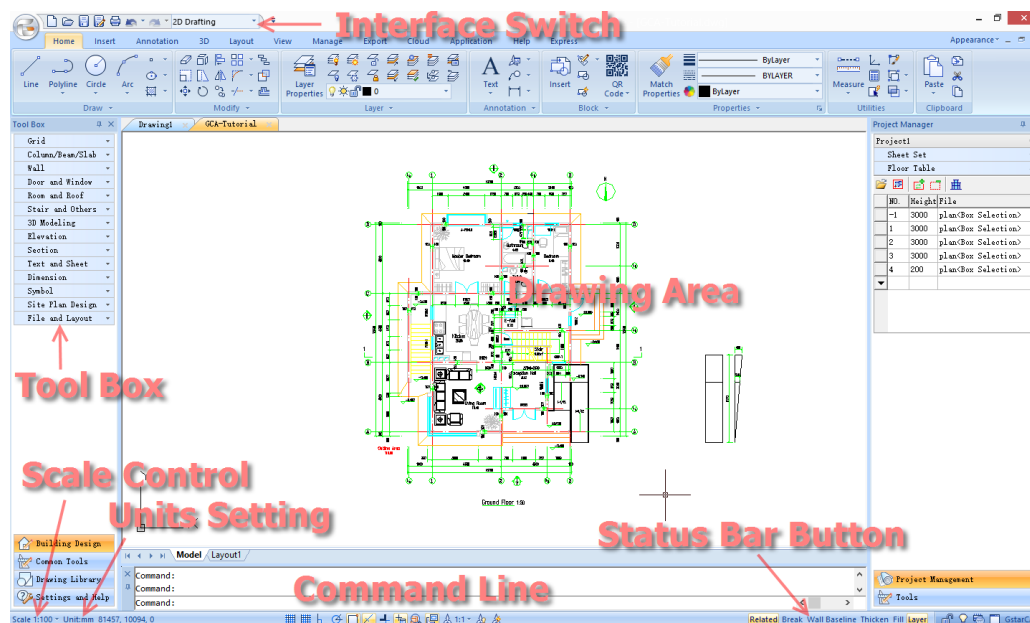

Fig 5. Interface introduction

The main functions are integrated in toolbox. It is most commonly used in actual drawing. You could find all functions by clicking pull-down menu in toolbox. GstarCAD Architecture also provides general functions of CAD platform, such as move, Copy, Mirror, Delete, and so on. To master GstarCAD Architecture requires the capability of using CAD.

If closed the toolbox dialog box by mistake, you could display it by pressing combination key "ctrl + =".

4. Design and Operation

GstarCAD Architecture is designed from the architects' points of view, and you could master it and apply it to

practical work in a short time. The main work of architecture design is focused on plan drawings, let's introduce as below:

1. Draw location grids and axis tags in plan drawing, and set reference guide lines.
2. Draw walls in plan drawing, and determine function rooms division and their positional relationship.
3. Draw columns in plan drawing.
4. Draw doors, windows, and holes in plan drawing.
5. Draw stairs in plan drawing.
6. Draw balconies, steps, and aprons in plan drawing.
7. Draw roofs in plan drawing.
8. Dimension.
9. Symbols.
10. Text and table.
11. Project Management (relationship of architecture plan, model, elevation, and section).
12. Draw elevation and section.
13. Assemble and export 3D model.

5. Case Study

In the following page, taking a small modern style villa for example, you could study some commands of GstarCAD Architecture (hereafter called GCA) and experience most of its functions.

5.1. Draw grids in plan drawing

Objective: Draw location grids and set reference guide lines in plan drawing.

Methods: Draw Grid command.

- (1) After starting the Draw Grid command, the following dialog box pops up. It could export parameters by entered table.

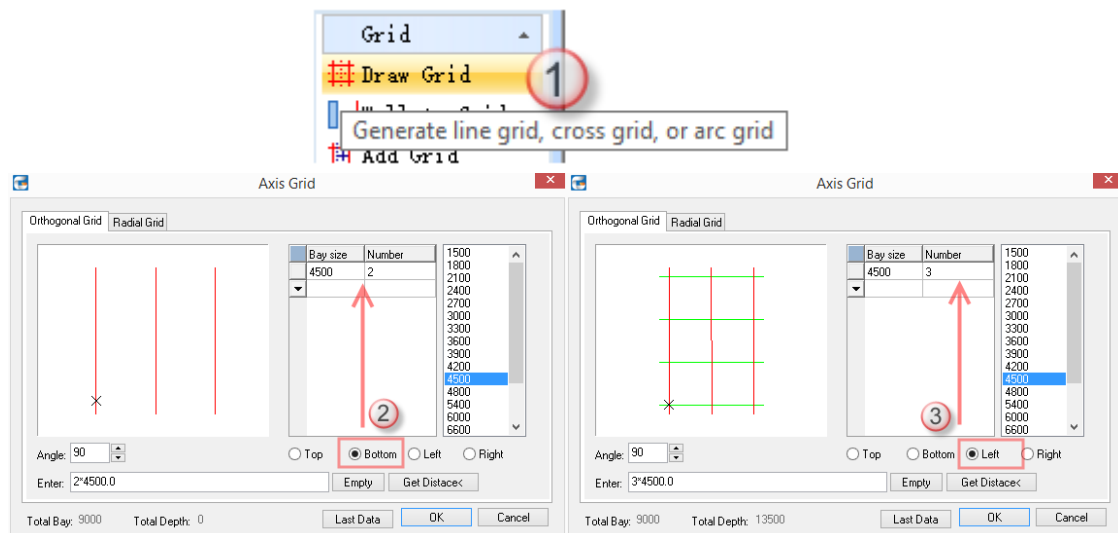

Fig 6. Draw Grid dialog box

The following table is grid parameters of first floor plan drawing.

	Bay Size	Number
Bottom	4500	2
Left	4500	3

- (2) Click Ok to preview grids. You could specify grid insertion position and insertion way in model space according to prompts displayed in command line as shown below:

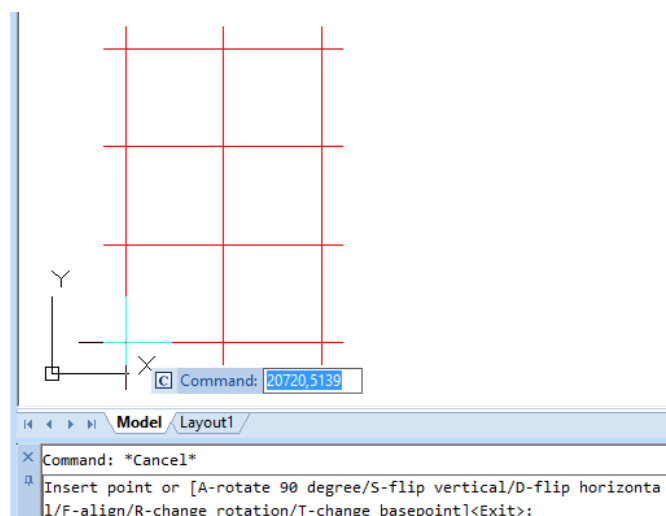

Fig 7. Insert grids

- (3) Insert grids by clicking anywhere in drawing area.

5.2. Grid Dimension in plan drawing

Objective: dimension on created grid

Methods: Grid Dimension command

- (1) Click Grid Dimension command in menu;

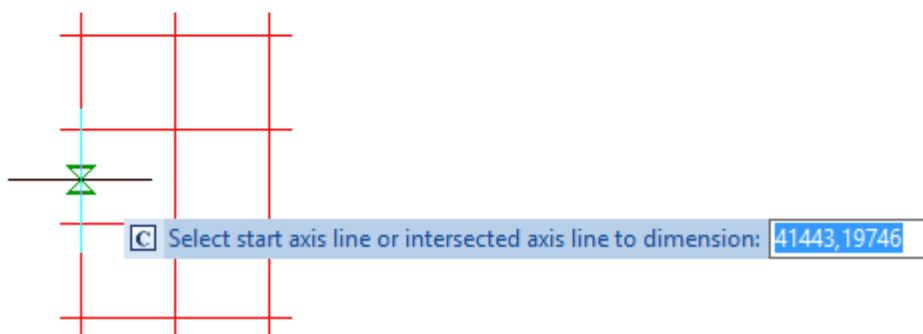
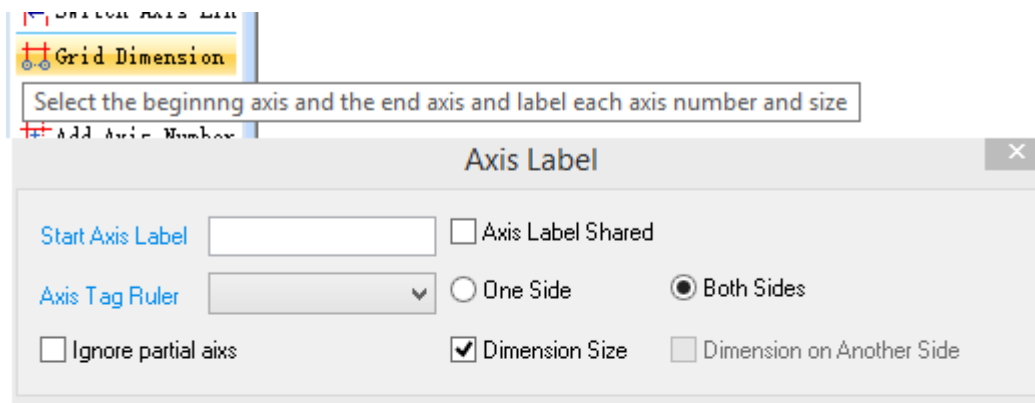

Fig 8. Grid Dimension

- (2) Specify the start point and end point according to prompts, the ruler of specifying start point and end point is displayed as below: (p1 is start point, p2 is end point);

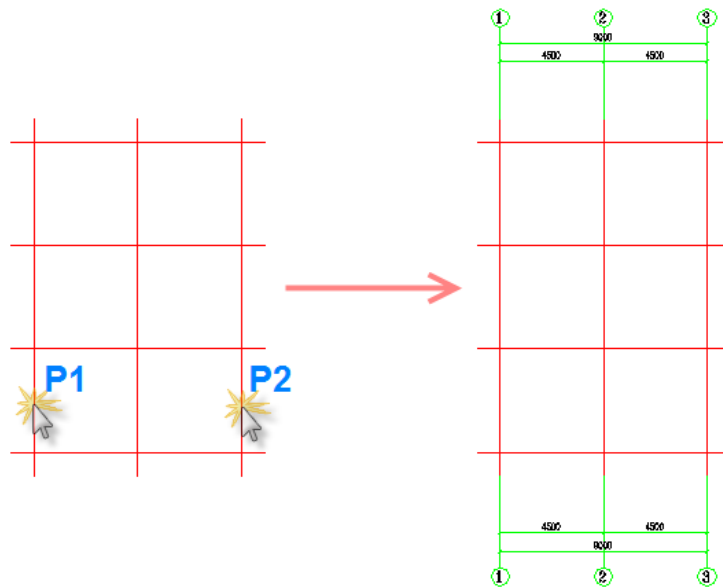

Fig 9. Grid Dimension - Horizontal

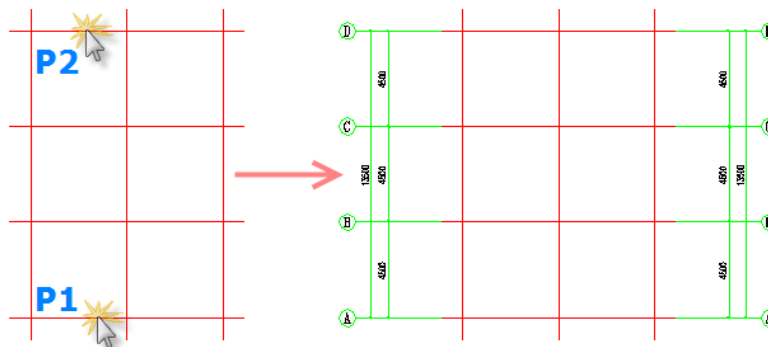

Fig 10. Grid Dimension - Vertical

- (3) It creates dimensions and tags by selection order. If the order is reversed, all tags will reverse. You could practice to draw grids and create dimensions as shown below:

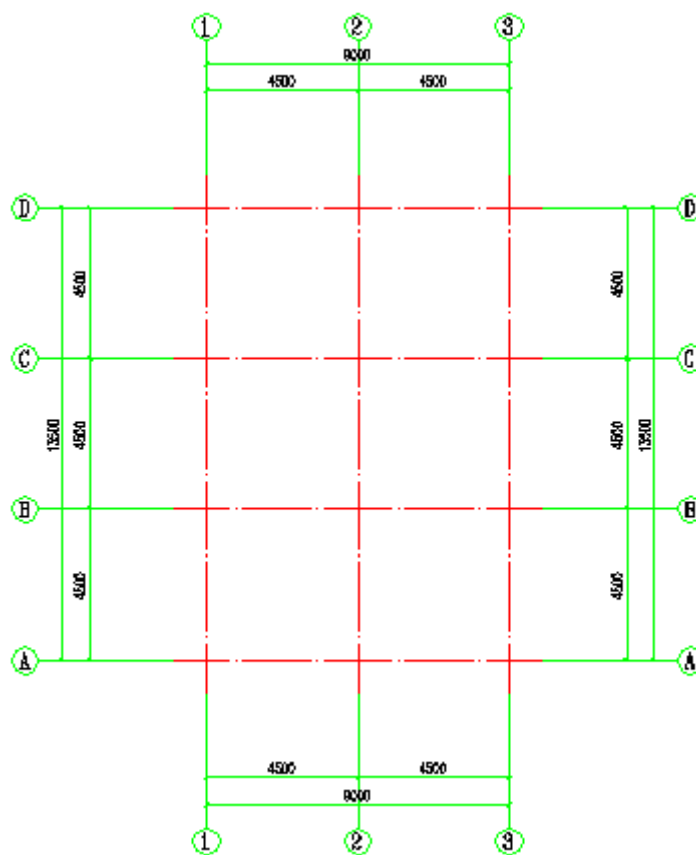

Fig 11. Finish grid dimensioning

There are many other settings, you could learn more by Help document or practice.

5.3. Draw walls in plan drawing

Objective: draw walls, and divide region into various types of rooms.

Methods: Draw Wall command.

- (1) The Wall dialog box pops up after clicking Draw Wall command. You could set wall parameters in this dialog box, such as height, thickness, materials, purpose of use, and so on.

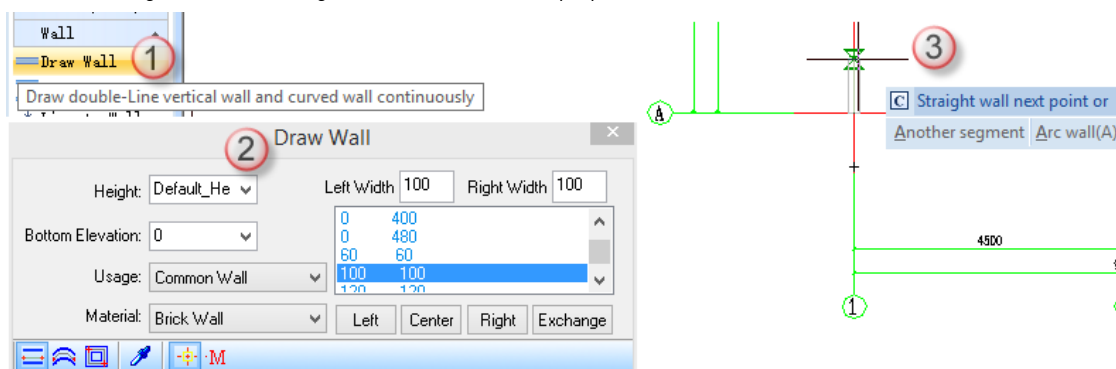

Fig 12. Wall

- (2) The wall thickness is related to drawing direction. For example, P1 is start point of wall, and P2 is end point of wall, you could see the difference of left width and right width as shown below:

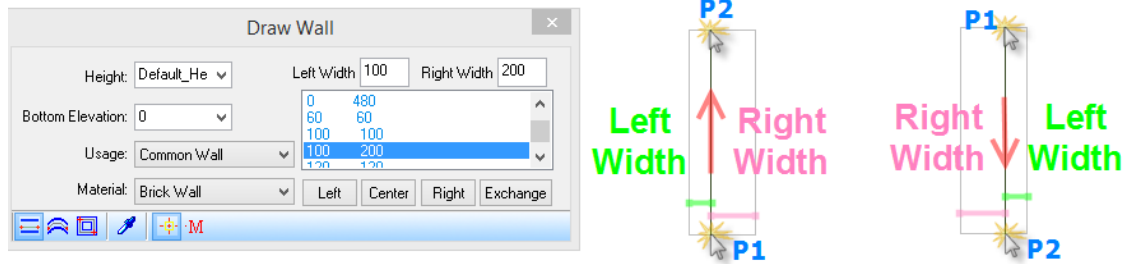

Fig 13. Relationship of wall thickness and drawing direction

- (3) Double click wall to edit it. The color of wall is related to left width and right width.

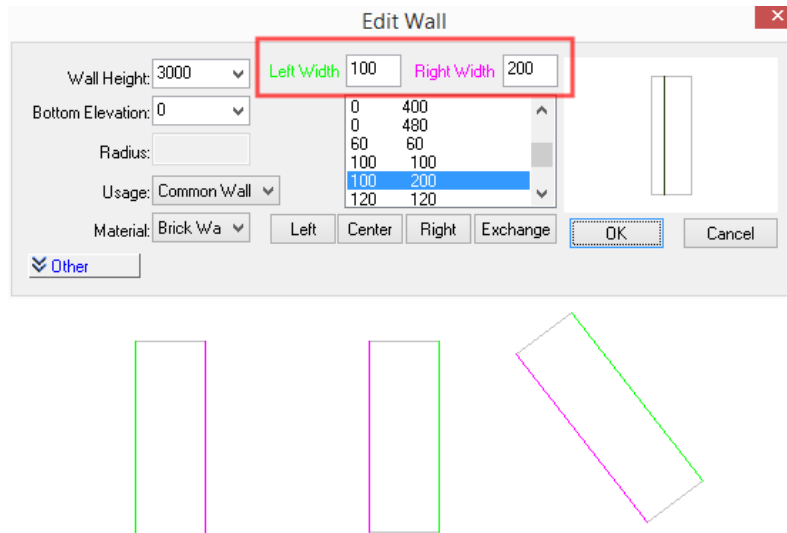

Fig 14. Edit left width and right width of wall

- (4) You could edit walls by some commands of CAD platform, such as Copy, Move, Rotate, Trim, Extent, and so on; and practice to draw walls as shown below (wall width is 200 mm by default, but it could be customized):

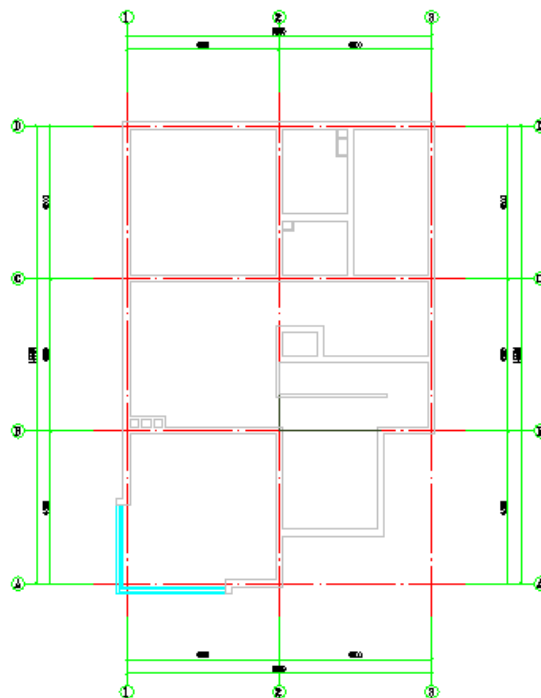

Fig 15. Finish wall dimensioning

5.4. Draw columns in plan drawing

Objective: draw columns in plan drawing and initially complete the structural arrangement.

Methods: Standard Column command.

GCA provides a variety of column types and ways to insert. It is very simple to edit columns, for example, you could edit a column by dragging grips on it. It also supports some commands of CAD platform, such as Copy, Move, Rotate, and so on.

- (1) Start Standard Column command, enter 400 X 400 to set column size in dialog box, insert the column to drawing, and place it to an appropriate position. Steps as shown below:

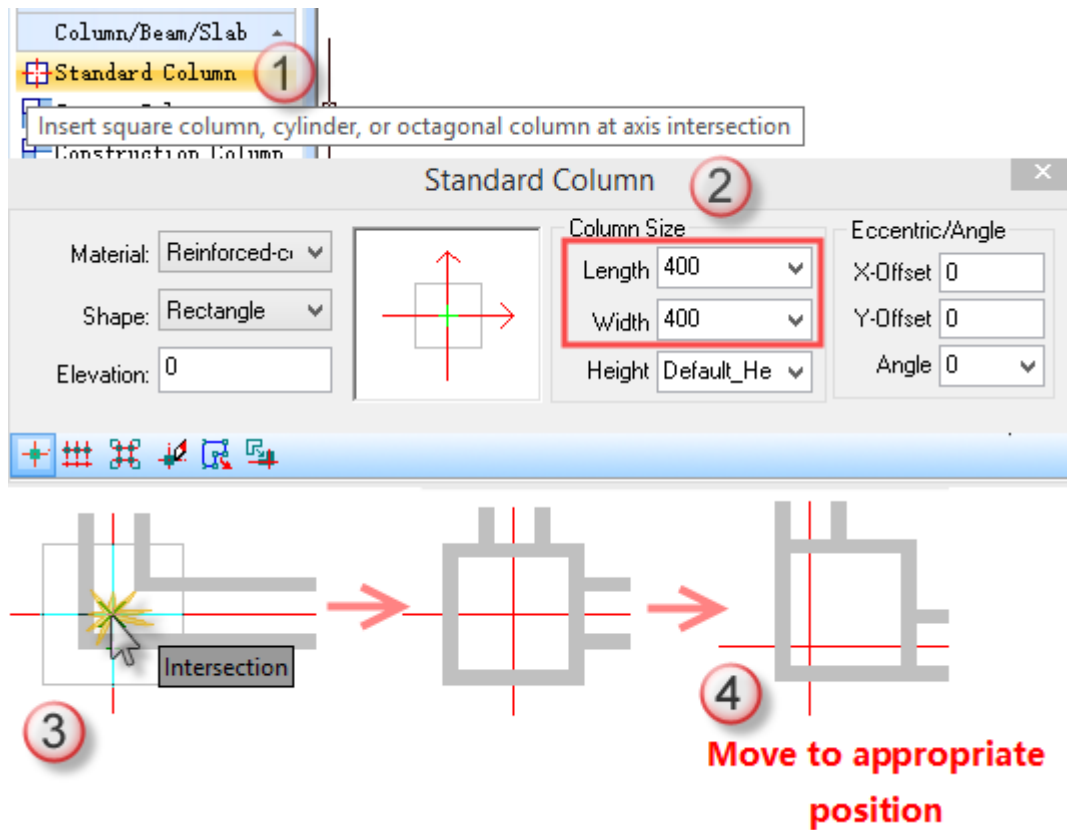

Fig 16. Column

- (2) The effect of column is related to settings for materials, scale factors, and hatch mode. It is helpful to master settings for them when drawing or editing columns. View effect as below:

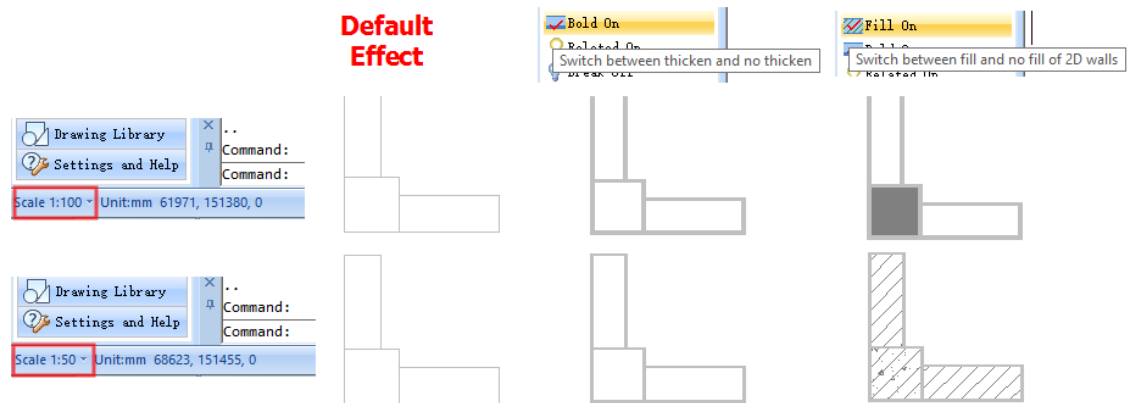

Fig 17. Effects for different settings for scale factors, bold, and hatch

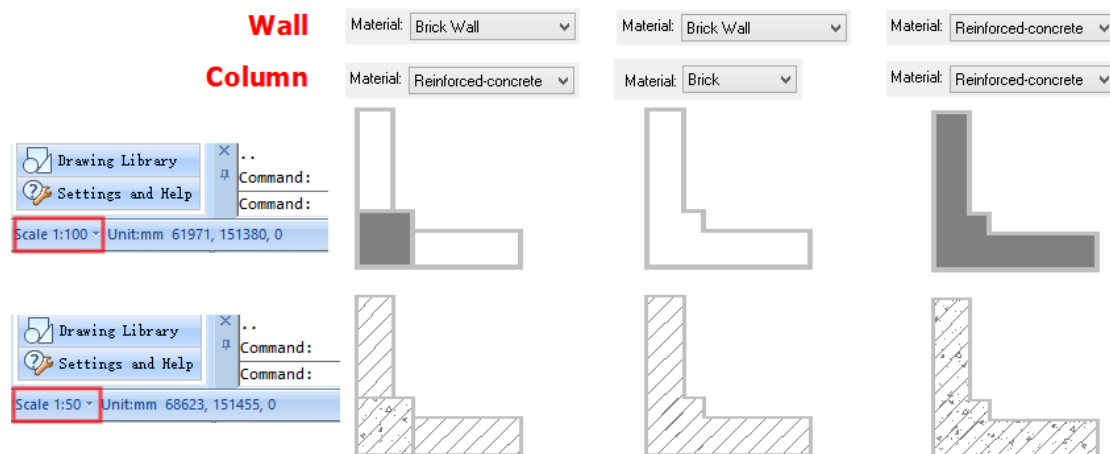

Fig 18. Effects for different settings for scale factors, materials, bold, and hatch

(3) There are many other settings, you could learn more by Help document or practice.

5.5. Draw win-door in plan drawing

Objective: draw win-door on wall.

Methods: Door/Window command.

GCA provides a variety of win-door styles, including plan and elevation styles. It supplies some parameters, such as width, height, distance from sill bottom to ground, tag, classification, and so on; it also offers many ways to insert win-doors. The dialog box could help designers draw win-doors in a simple way.

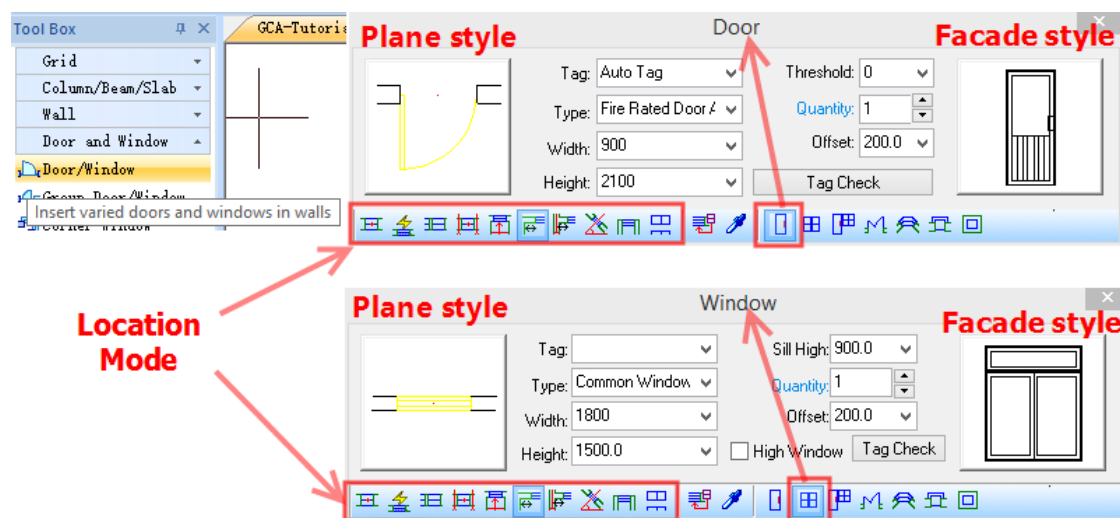

Fig 19. Door and Window dialog box

Steps to insert a door without tag:

- (1) First to make sure that there is wall segment with sufficient width in drawing;
- (2) Click Win-door command;
- (3) Click Door icon in dialog box;
- (4) Set insertion way to be distance from wall pier;
- (5) Set tag to be empty; set door width to be 1000, door height to be 2200, number to be 1, and Offset distance to be 200;
- (6) Click on the wall to finish door insertion.

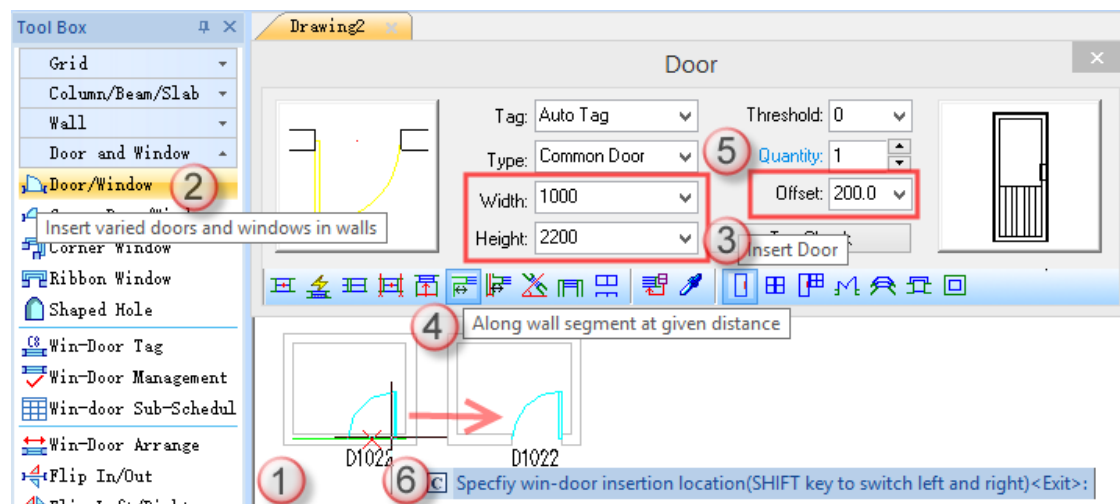

Fig 20. Operation Guide for Door

Steps to insert a window with tag:

- (1) First to make sure that there is wall segment with sufficient width in drawing;
- (2) Click Win-door command;
- (3) Click Window icon in dialog box;
- (4) Set insertion way to be wall center;
- (5) Set tag to be auto, window width to be 1200, window height to be 1500, and number to be 1;
- (6) Click on the wall to finish window insertion.

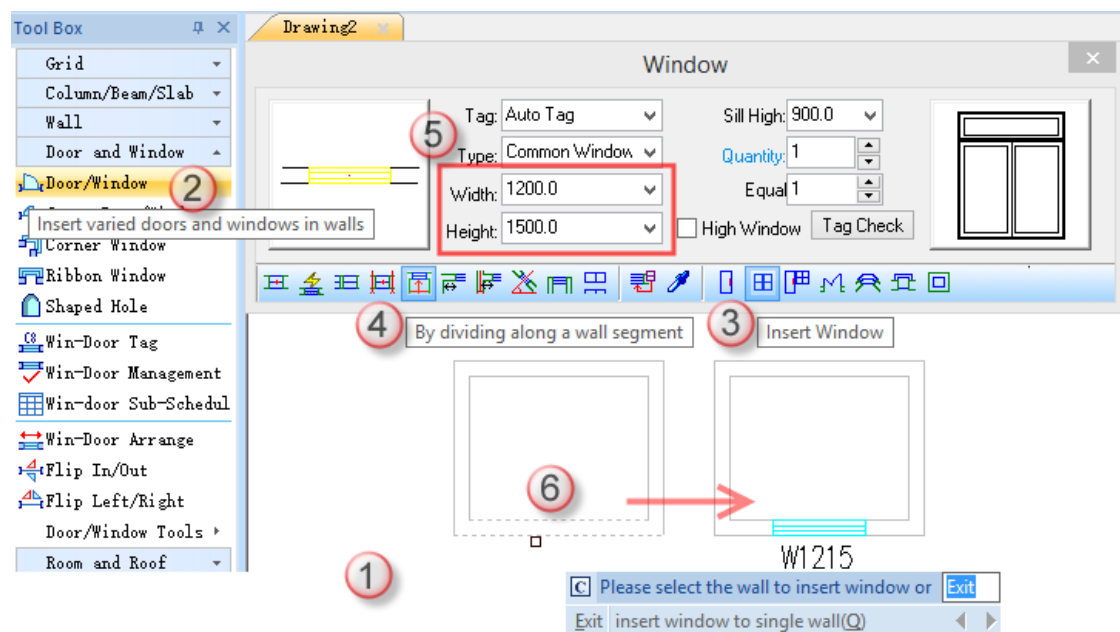

Fig 21. Operation Guide for Window

The parameters in Win-door dialog box is very simple, you could practice to insert different types of doors, windows, bay windows, and holes.

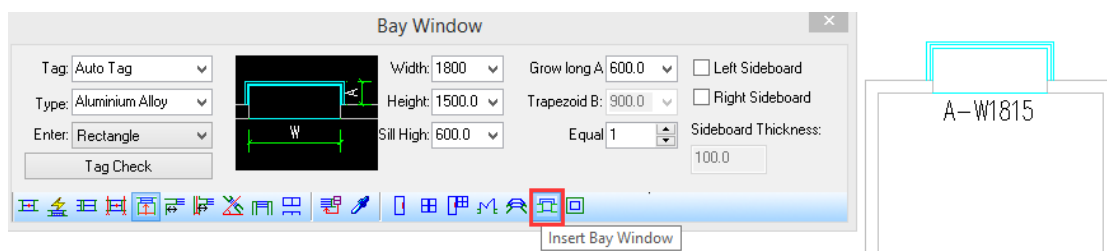

Fig 22. Insert Bay Window

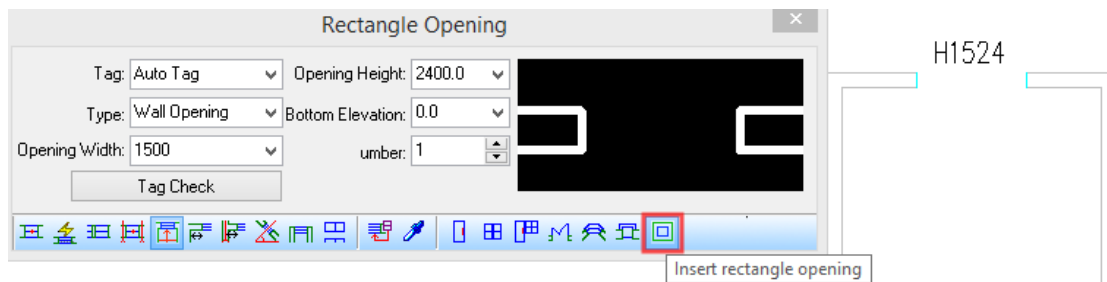

Fig 23. Insert Hole

You could also edit inserted win-dors by command of CAD platform, such as Copy, Move, Delete, and so on.

5.6. Draw corner windows in plan drawing

Objective: insert corner windows to wall corner.

Methods: Corner Window command.

- (1) First to make sure that there is an appropriate wall corner in drawing;
- (2) Click Corner Window command;
- (3) Set window width 1 to be 1000, window width 2 to be 1500 (it could be changed according to specified circumstance. Preview it by moving mouse to wall corner, and then edit values of window width);
- (4) Click on wall corner to finish corner window insertion.

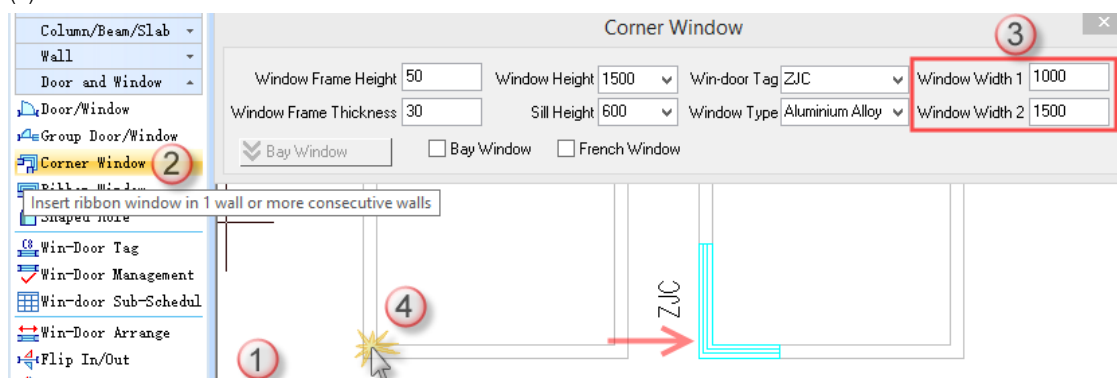

Fig 24. Operation Guide for Corner Window

You could edit corner window style by dragging grips on it.

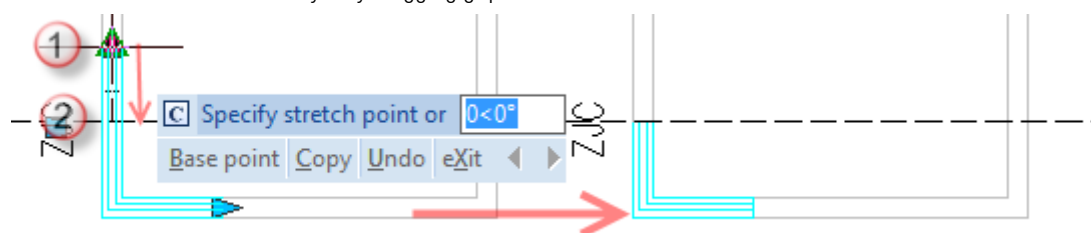

Fig 25. Grip editing for Corner Window

The dialog box is very simple, you could try to modify parameters and enjoy different effects.

5.7. Draw U-shaped stair in plan drawing

Objective: insert appropriate stairs to drawing.

Methods: U-Shaped Stair command.

GCA provides lots of stair styles. In this guide, we will introduce the most commonly used U-shaped stair. You could draw and edit your drawings by GCA and get a deeper understanding of it.

- (1) First to make sure that there is a underlay in drawing;
- (2) Click U-Shaped Stair command;
- (3) (3) Set Staircase width to be 1900 (it could be changed according to specified circumstance. Preview it by moving mouse to wall corner, and then edit values of window width);
- (4) It displays the preview effect when moving mouse to drawing area. Note: it is unnecessary to specify stair location by clicking.
- (5) Please pay attention to command prompts in command line, enter "A" to rotate inserted stair by 90 degrees. You could rotate several times and place it to an appropriate position.

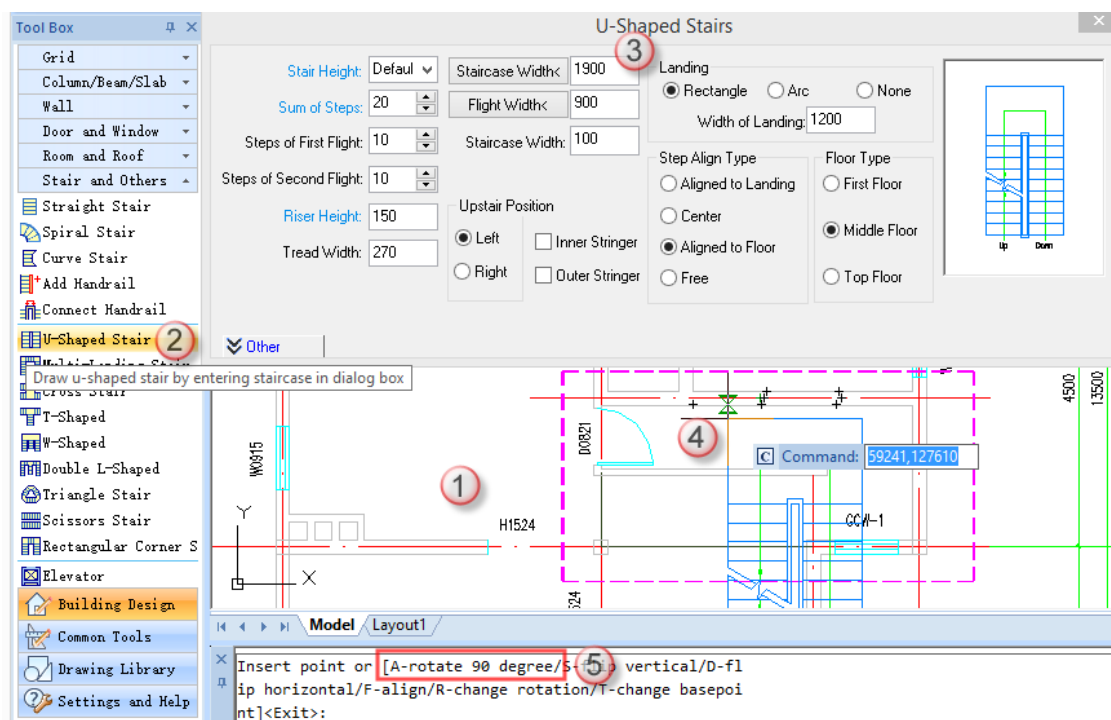

Fig 26. Operation Guide 1 for U-Shaped Stair

- (6) Specify stair insertion position to complete.
- (7) You could edit stair parameters in dialog box by double clicking the stair.
- (8) Set floor type to be first floor and click OK. It displays the finally stair style (if you have already familiar with effects of different settings, you could set them all at the beginning).

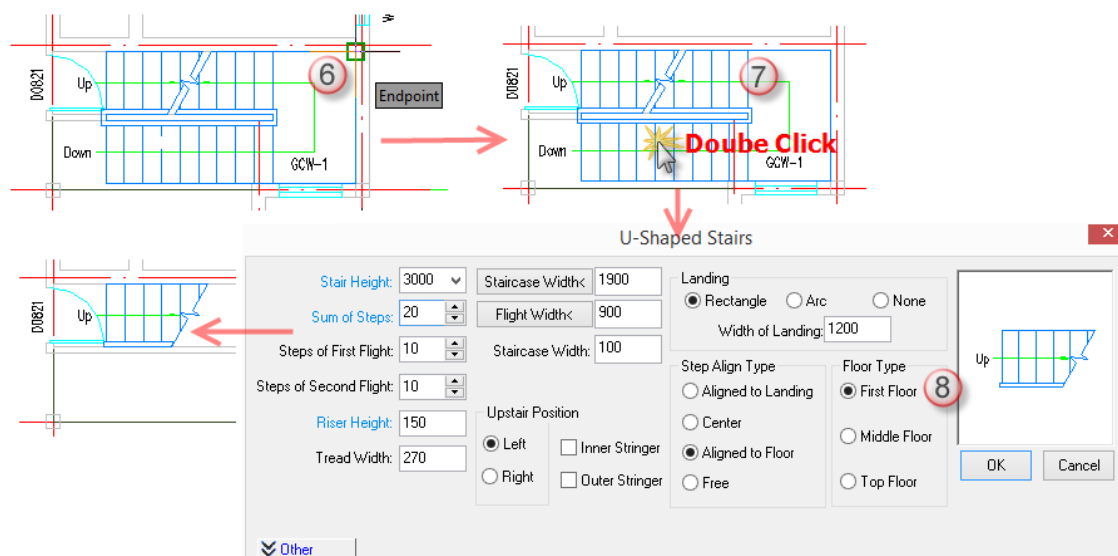

Fig 27. Operation Guide 2 for U-Shaped Stair

The dialog box is very simple, you could try to modify parameters and enjoy different effects. You could also edit inserted stairs by command of CAD platform, such as Move, Copy, Rotate, Mirror, Delete, and so on. GCA supplies grip editing functions, you could edit stair by dragging grips on it.

5.8. Draw steps in plan drawing

Objective: draw appropriate steps in drawing.

Methods: Step command.

After clicking Step command, it displays a dialog box, at the same time you should pay attention to command prompts in command line. You could draw steps by specifying its start point and end point.

- (1) First to make sure that there is a underlay in drawing;
- (2) Click Step command;
- (3) In dialog box, set platform width to be 1500 mm; select Endpoint Location for insert way, select Rectangle Single Side Step, General Step, and Landing Surface.
- (4) Specify the first insertion point; in the process of inserting the second point, you could see the step direction and you could switch direction by pressing F key.
- (5) After specifying the second point, you complete drawing steps.

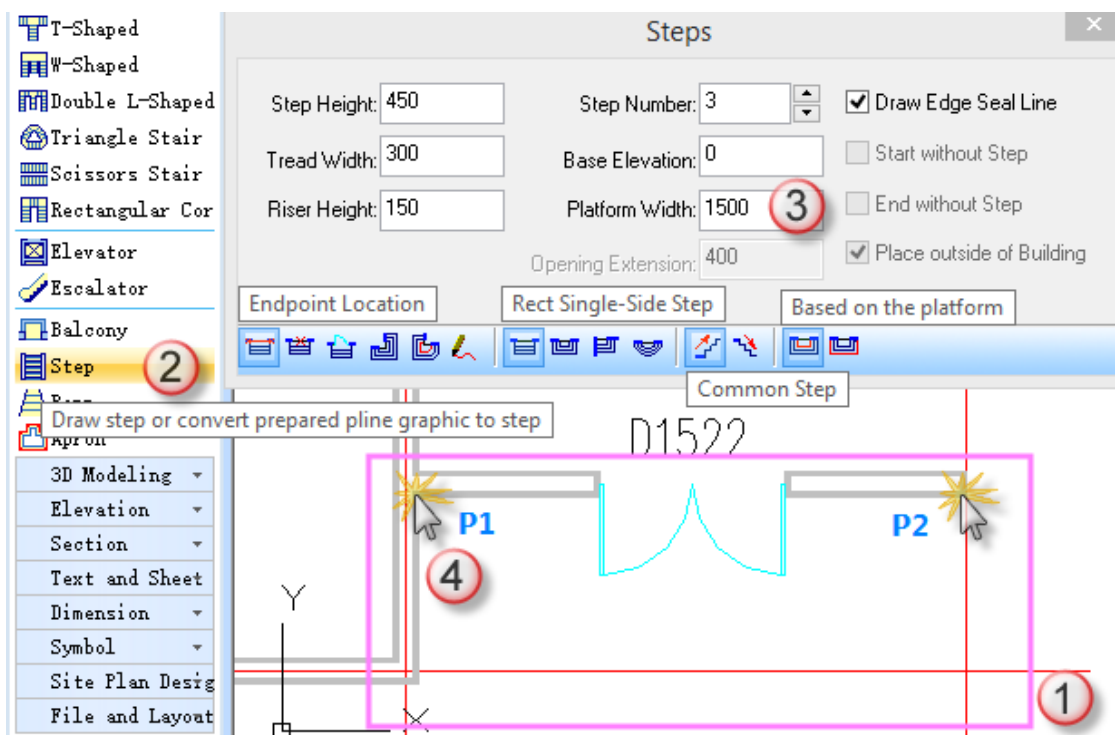

Fig 28. Operation Guide for Step

If steps intersected with a column, GCA will auto process it as shown below:

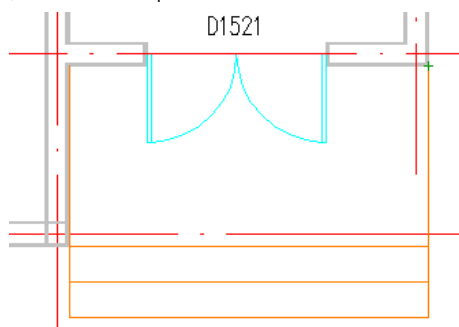

Fig 29. Step

The dialog box is very simple, you could try to modify parameters and enjoy different effects.

You could also edit inserted steps by command of CAD platform, such as Move, Copy, Rotate, Mirror, Delete, and so on. GCA supplies grip editing functions, you could edit step by dragging grips on it.

5.9. Draw apron in plan drawing

Objective: draw appropriate aprons in drawing.

Methods: Apron command.

After clicking Apron command, it displays a dialog box, in which you could set apron parameters to draw appropriate apron in drawing.

- (1) First to make sure there is a underlay in drawing;
- (2) Click Apron command;
- (3) Set parameters in pop-up dialog box, and click Search to Auto Generate;
- (4) Box select the first floor plan as shown below in blue frame:

- (5) After setting, the new apron automatically generated. If the apron meets columns, steps, or balcony, it will be hidden automatically.

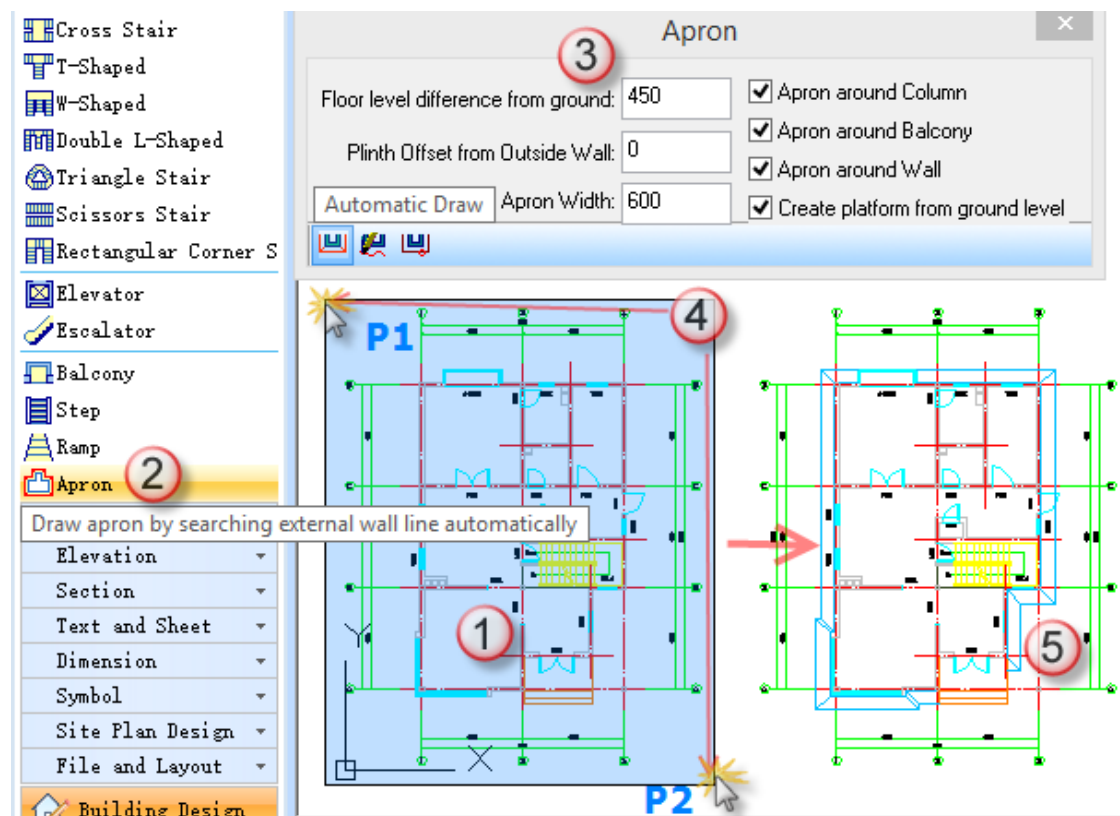

Fig 30. Operation Guide for Apron

The dialog box is very simple, you could try to modify parameters and enjoy different effects. You could also experience different ways to draw apron.

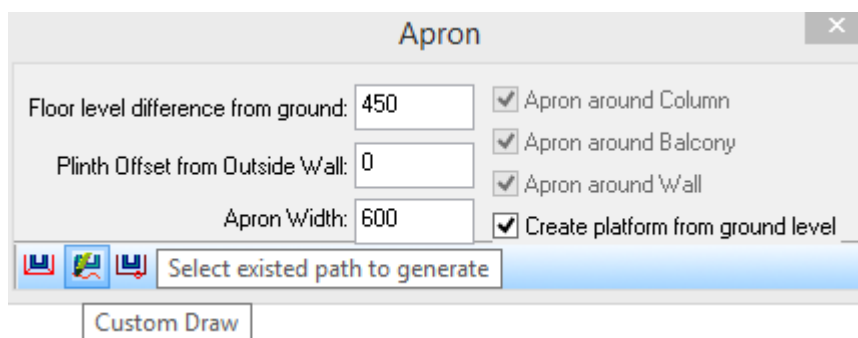

Fig 31. Other ways to draw aprons

5.10. Draw balcony in plan drawing

Objective: draw a balcony in drawing.

Methods: Balcony command.

After clicking Balcony command, it displays a dialog box, in which you could set balcony parameters to draw an appropriate balcony in drawing.

- (1) First to make sure that there is a underlay in drawing;

- (2) Click Balcony command;
- (3) Set parameters in pop-up dialog box, set Railing Height to be 1100 and click Rectangular Three Sides Balcony;
- (4) Specify the start point of balcony in drawing as p1 shown in drawing, and specify the second point of balcony as p2. You could adjust balcony direction by press F key.
- (5) Finish drawing balcony.

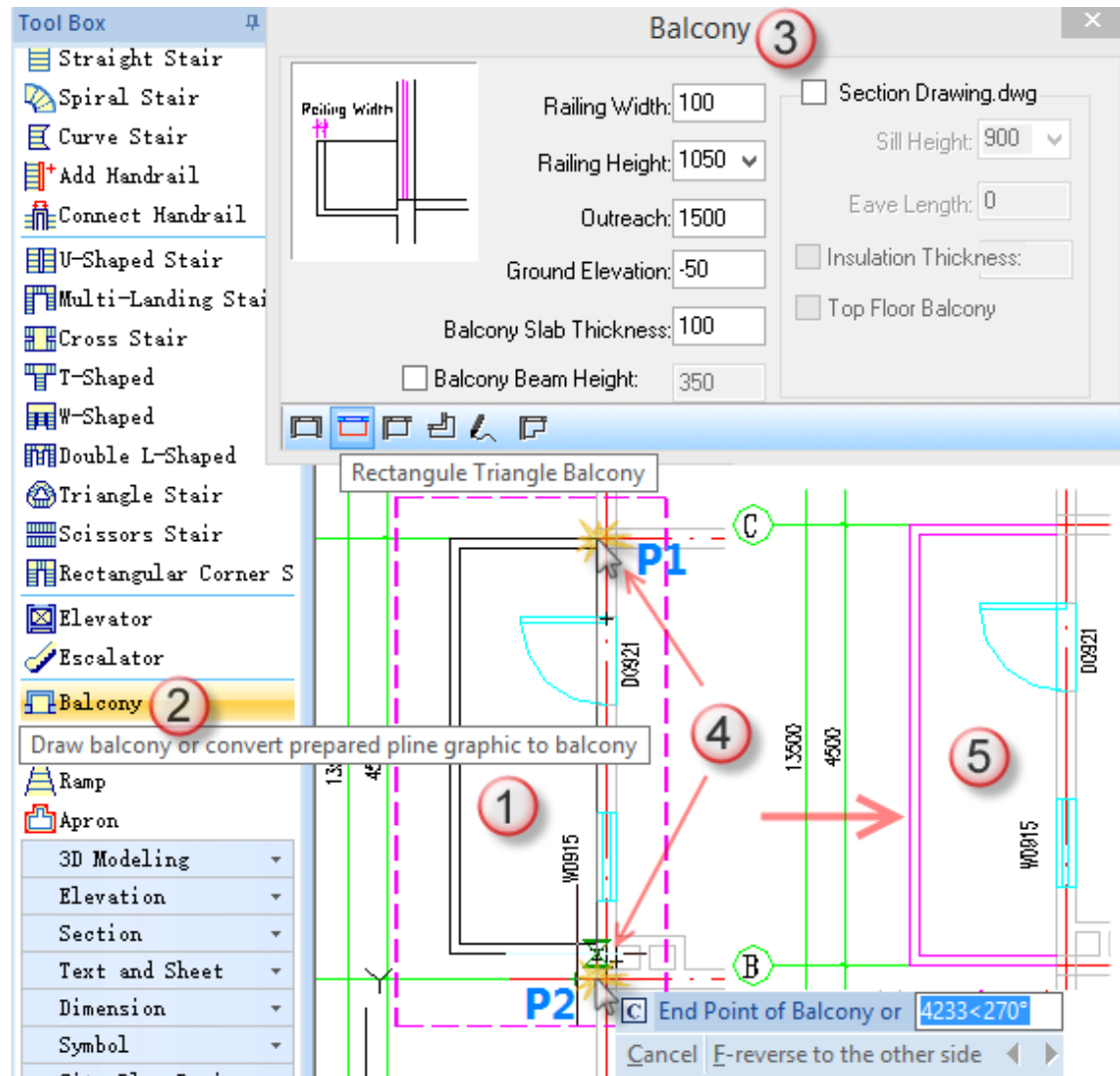

Fig 32. Operation Guide for Balcony

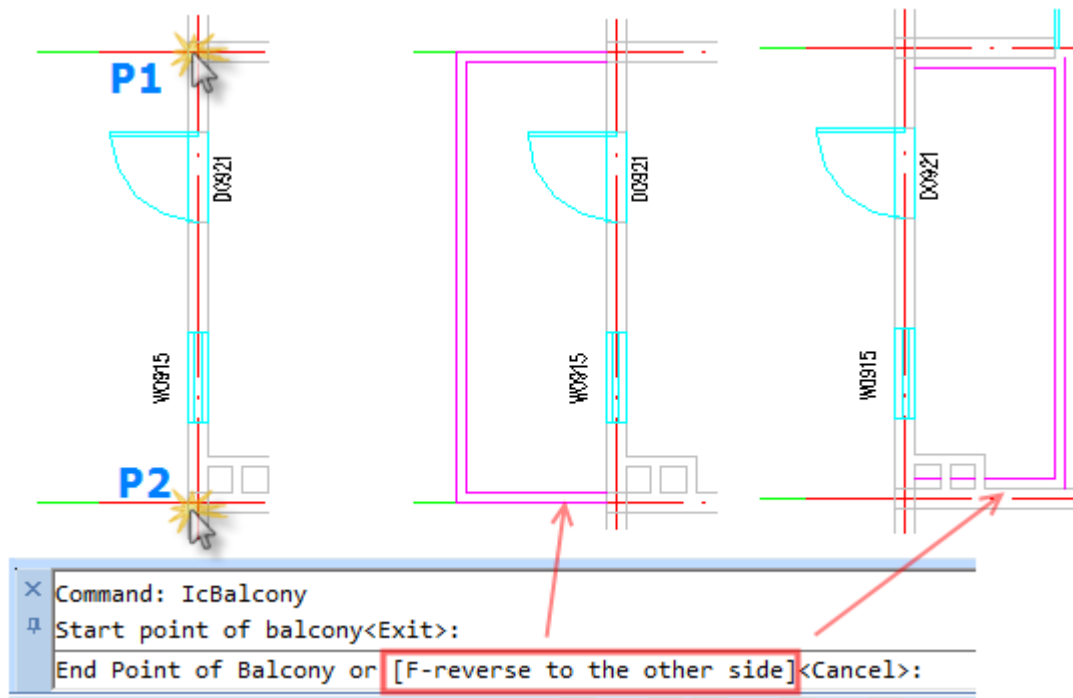

Fig 33. Switch Balcony Drawing Direction

The dialog box is very simple, you could try to modify parameters and enjoy different effects. You could also experience different ways to draw balcony.

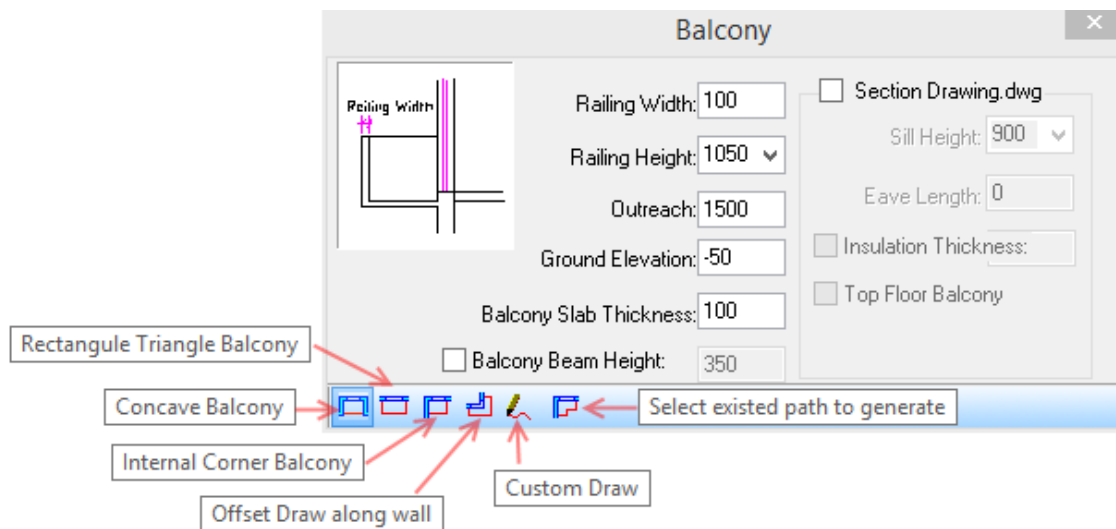

Fig 34. Ways to draw balcony

5.11. Draw roofs in plan drawing

Objective: draw a roof in drawing.

Methods: Roof command.

- (1) Draw the roof side line in plan drawing and it must be closed pline;
- (2) Click Roof command;
- (3) Select the created pline according to command prompts;
- (4) Press Enter key, enter slope angle and other parameters by default, and then press Enter key again;
- (5) Finish drawing roof.

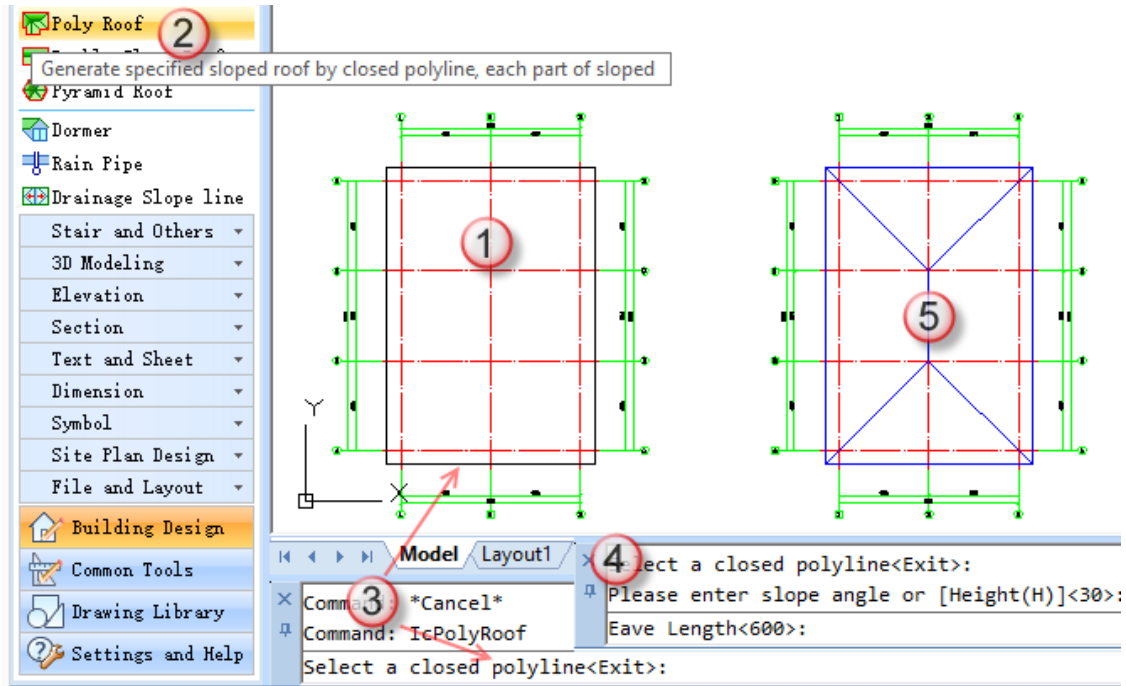

Fig 35. Operation Guide for Drawing Roof

The dialog box is very simple, you could try to modify parameters and enjoy different effects. You could also experience different ways to draw roof.

5.12. Linear Dimension

Objective: Linear dimension in drawing.

Methods: Linear Dimension, Subjoin Dimension, Bay Combine, Remove Dimension.

GCA supplies intelligent object technology for dimensions. It has something different from GstarCAD. You should use special dimensioning functions of GCA to create and edit dimensions, such as Linear Dimension, Subjoin Dimension, Bay Combine, or Remove Dimension, rather than use dimensioning functions of GstarCAD. Styles of GCA are also different from GstarCAD. You could create new styles and apply them on dimensioning objects.

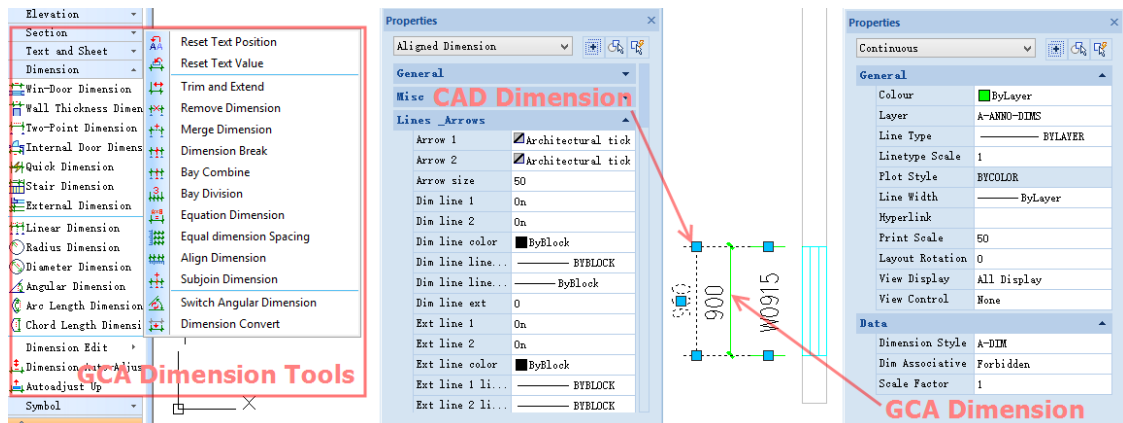

Fig 36. Difference of dimension objects between CAD and GCA

After clicking Linear Dimension command, specify two points on dimension object, and continuous specify other points in the same direction, and then dimensions are automatically added. After all operations of Linear Dimension command, all added dimensions are a whole part.

- (1) Specify objects to dimension in plan drawing;
- (2) Click Linear Dimension command and pop-up a dialog box;
- (3) Specify p1 and p2 to locate dimension line as the start point and end point, specify p3 to determine the location of dimension line;
- (4) Continuous specify other points for automatic dimensioning along dimension line, such as p4.
- (5) Press enter key to finish. All dimensioning objects are a whole.

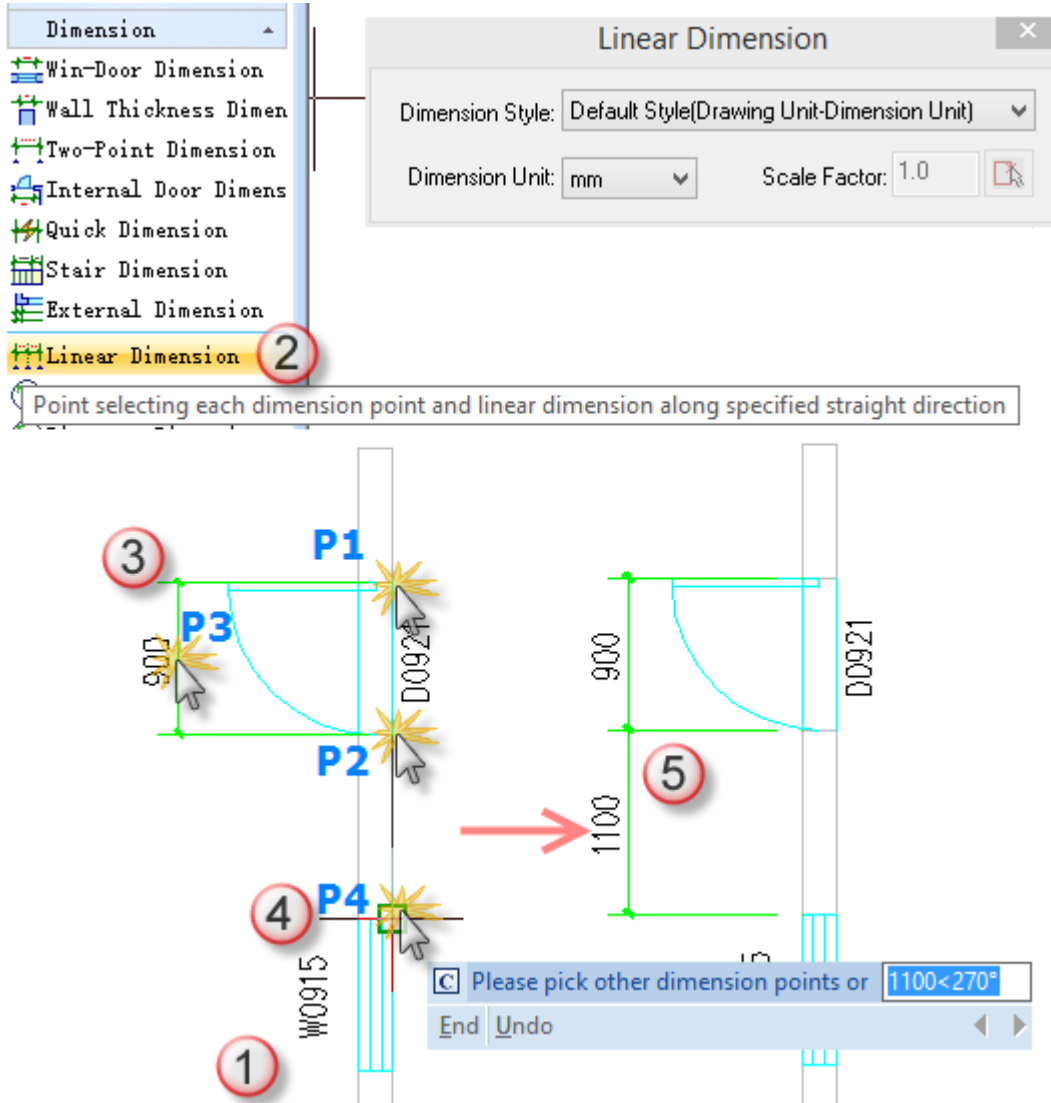

Fig 37. Operation Guide for Linear Dimension

5.13. Subjoin Dimension

Objective: dimension in drawing.

Methods: Subjoin Dimension.

GCA supplies intelligent object technology for dimensions. It has something different from GstarCAD. You should use special dimensioning functions of GCA to create and edit dimensions, such as Liner Dimension, Subjoin Dimension, Bay Combine, or Remove Dimension, rather than use dimensioning functions of GstarCAD. Styles of GCA are also different from GstarCAD. You could create new styles and apply them on dimensioning objects. You could subjoin dimension based on existing dimension. Clicking the dimension to subjoin on selected plan and

clicking the position to place the subjoined dimension, new dimension will be created based on existing dimension.

- (1) First to make sure that there is existed dimension object in GCA and there is at least one object needed to be dimensioned;
- (2) Click Subjoin Dimension command;
- (3) Select existed GCA dimension object;
- (4) Specify the point to dimension, such as P1;
- (5) New dimension is subjoined.

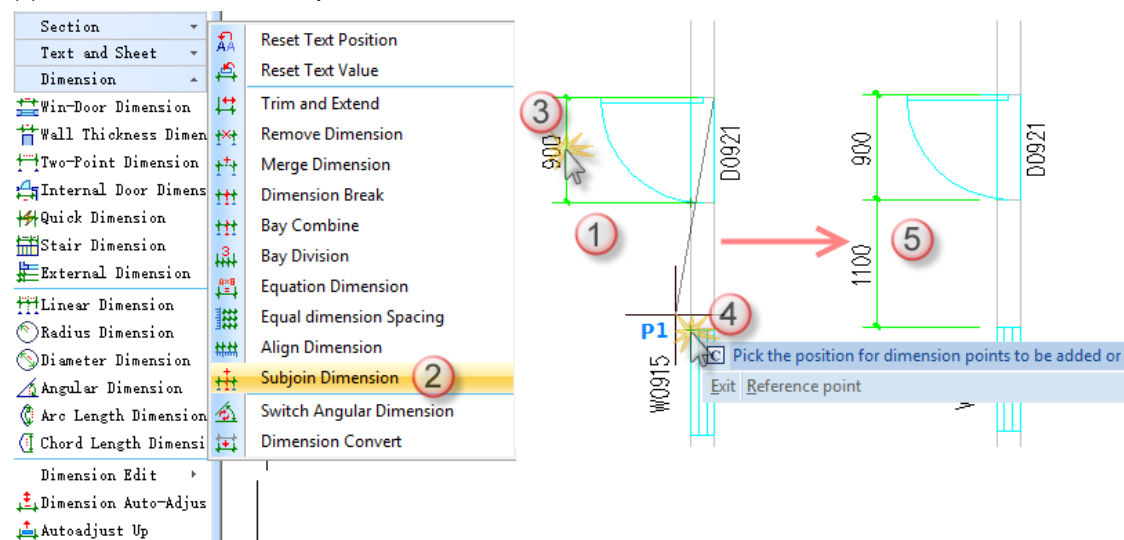

Fig 38. Operation Guide for Subjoin Dimension

The operation step is very simple, you could try to modify parameters and learn more.

5.14. Bay Combine

Objective: edit dimension in drawing and combine two bays.

Methods: Bay Combine command.

GCA supplies intelligent object technology for dimensions. It has something different from GstarCAD. You should use special dimensioning functions of GCA to create and edit dimensions, such as Liner Dimension, Subjoin Dimension, Bay Combine, or Remove Dimension, rather than use dimensioning functions of GstarCAD.

- (1) First to make sure that there is existed dimension object in GCA;
- (2) Click Bay Combine command;
- (3) Box select the arrow which connects with two bays;
- (4) Finish combining bays.

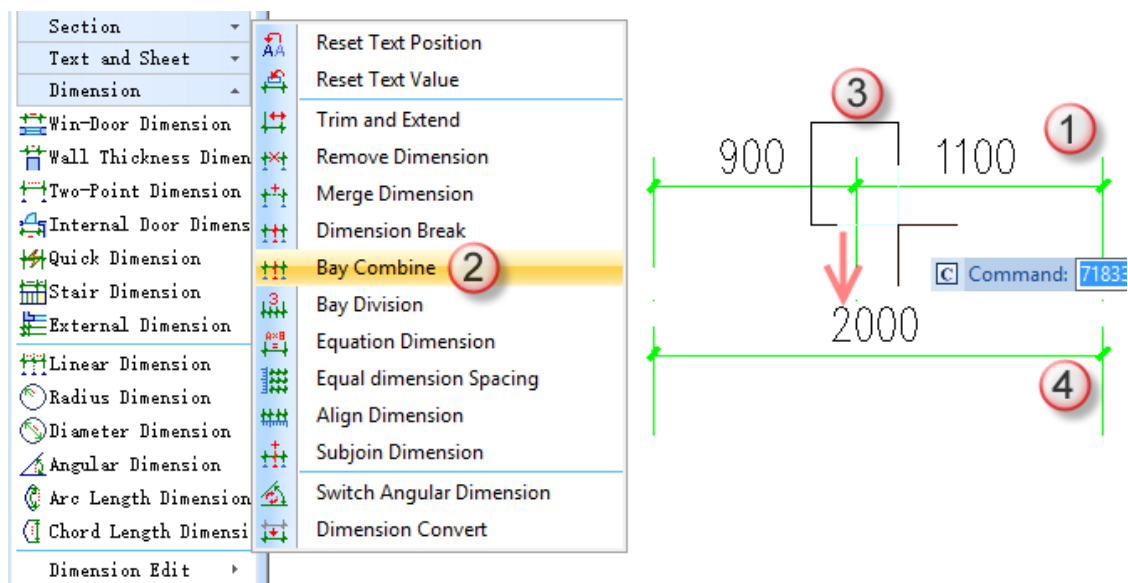

Fig 39. Operation Guide for Bay Combine

The operation step is very simple. You could try to modify dimension styles to learn more, and it could make work easier to combine Bay Combine command with Subjoin Dimension command.

5.15. Remove Dimension

Objective: edit dimension in drawing and remove a part of unnecessary dimension in GCA.

Methods: Remove Dimension command.

GCA supplies intelligent object technology for dimensions. It has something different from GstarCAD. You should use special dimensioning functions of GCA to create and edit dimensions, such as Liner Dimension, Subjoin Dimension, Bay Combine, or Remove Dimension, rather than use dimensioning functions of GstarCAD.

- (1) First to make sure that there is existed dimension object in GCA;
- (2) Click Remove Dimension command ;
- (3) Select unnecessary dimension bay;
- (4) Finish removing unnecessary dimension bay.

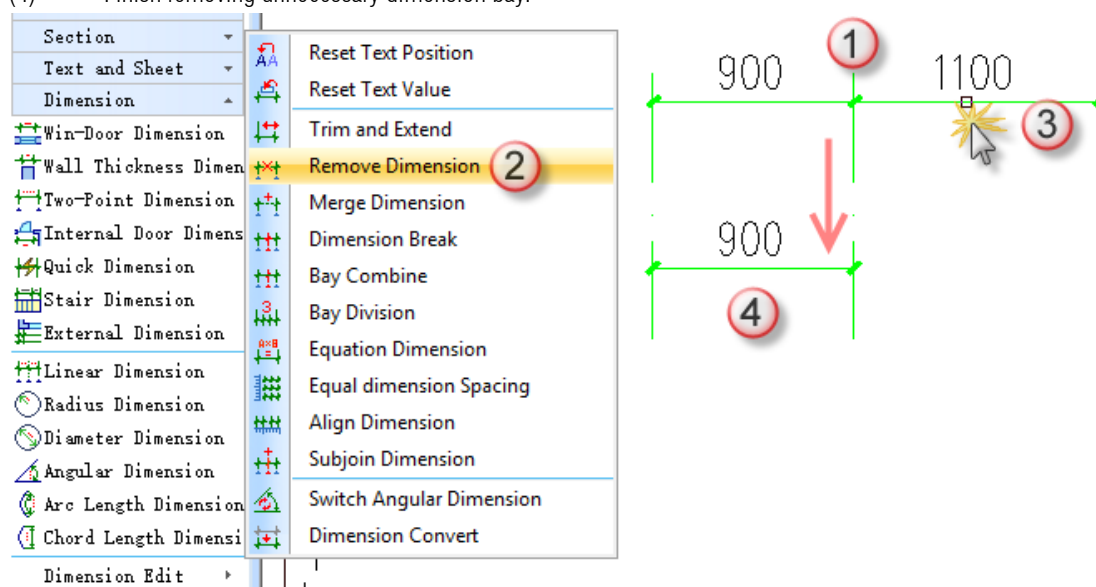

Fig 40. Operation Guide for Remove Dimension

5.16. Room Label

Objective: label room's mark in drawing

Methods: Search Room command

GCA supplies intelligent custom object technology. Room objects include room name, area, hatch, and so on. GCA could generate room objects by Search Room command in a fast way, on condition that the room is a closed region surrounded by wall objects of GCA. You could set which objects to display when generating room objects.

- (1) First to make sure that there exists building plan drawing and walls are connected and closed;
- (2) Click Search Room command;
- (3) In the pop-up dialog box, check Display Room Name, Dimension Area, Area Unit;
- (4) Box select walls in drawing, and pick p1 and p2;
- (5) It automatically generates room objects, including room name and area.

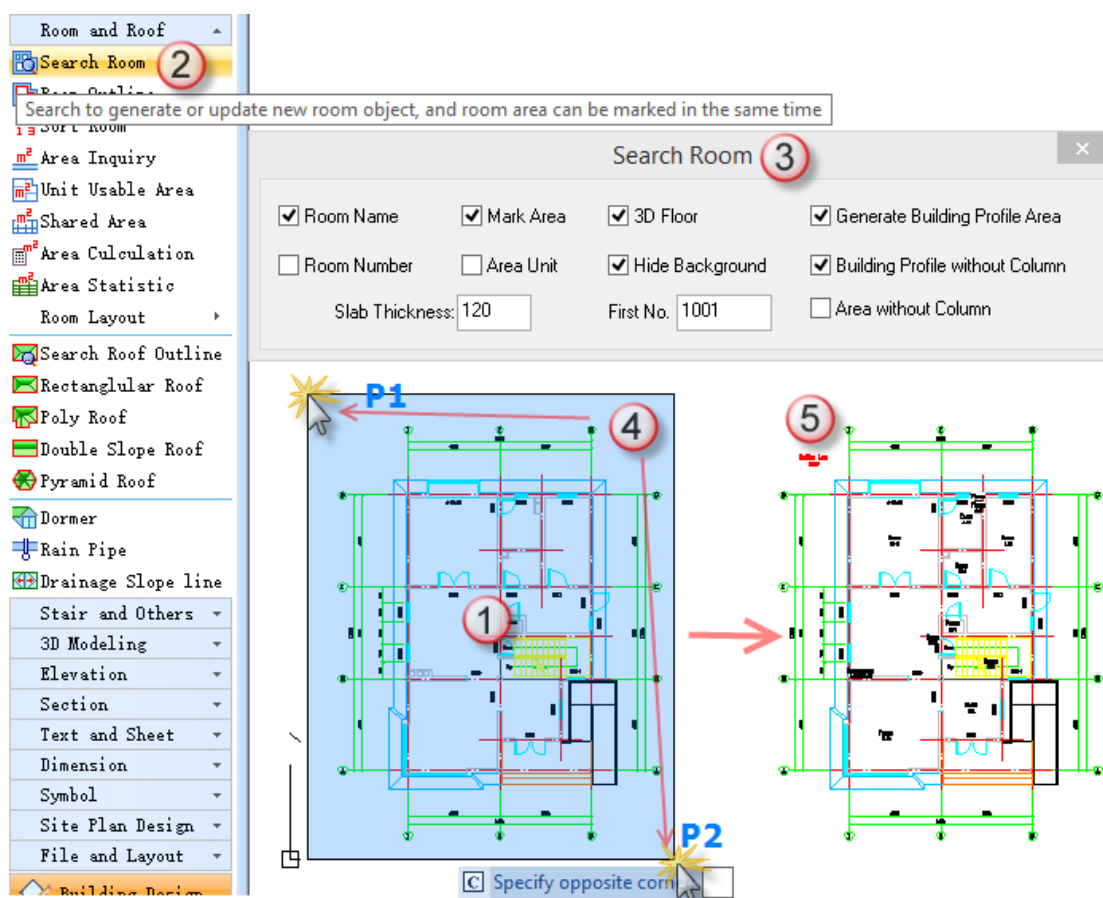

Fig 41. Operation Guide for Search Room

- (6) Click Object Edit command;
- (7) Select the room object to edit;
- (8) Enter "Study Room" in Name place;
- (9) The result displays as below.

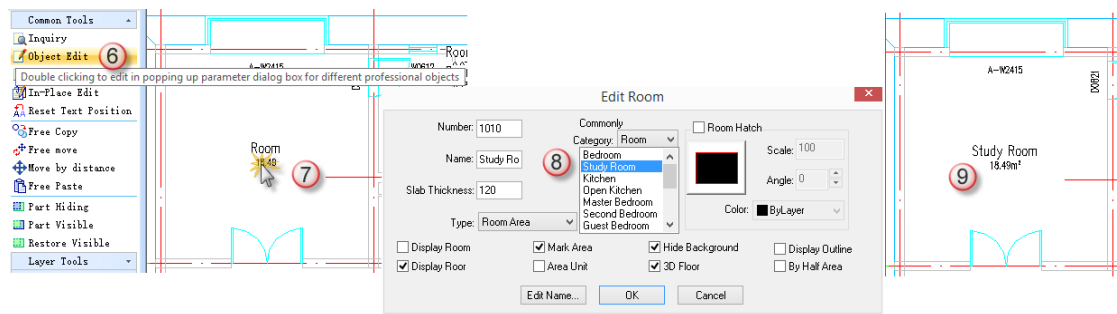

Fig 42. Room Object Editing

The dialog box is very simple, you could try to modify parameters and enjoy different effects.

5.17. Elevation Dimension

Objective: elevation dimension for plan drawing.

Methods: Elevation Dimension command.

In architecture plan, the ground elevation could be marked by Elevation Dimension function. Steps are as below: set elevation value and specify dimension location, and then specify text position.

- (1) Move the drawing to an appropriate position;
- (2) Click Elevation Dimension command;
- (3) Select Ground Elevation in pop-up dialog box and set it to be "0 "(or set to a value according to your requirement, unit is m);
- (4) Pick a point to locate elevation and specify text position in plane;
- (5) Finish elevation dimensioning.

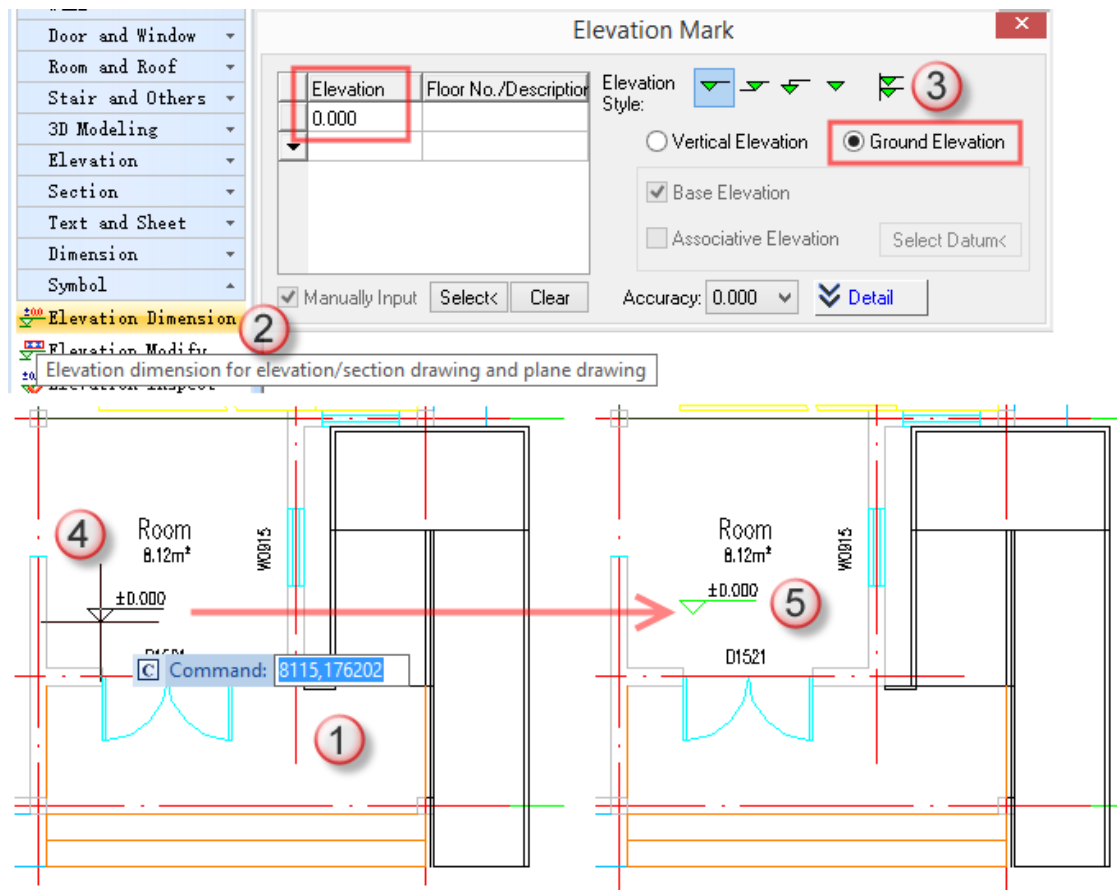

Fig 43. Operation Guide for Elevation Dimension

The dialog box is very simple; you could try to modify parameters to experience many effects.

5.18. Section Symbols Dimension

Objective: section symbols dimension in plan drawing.

Methods: Section Symbol Dimension.

Select the position to mark key section position and create section line by Section Symbol command. The section line is a very important line for generating section drawing.

- (1) Move the drawing to an appropriate position;
- (2) Click Section Symbol Command;
- (3) Set section serial number to be "1" in pop-up dialog box, and select Orthogonal Cut;
- (4) Specify section line start point p1 and end point p2 in drawing, and specify "View Direction" according to command prompts;
- (5) Finish drawing section symbol.

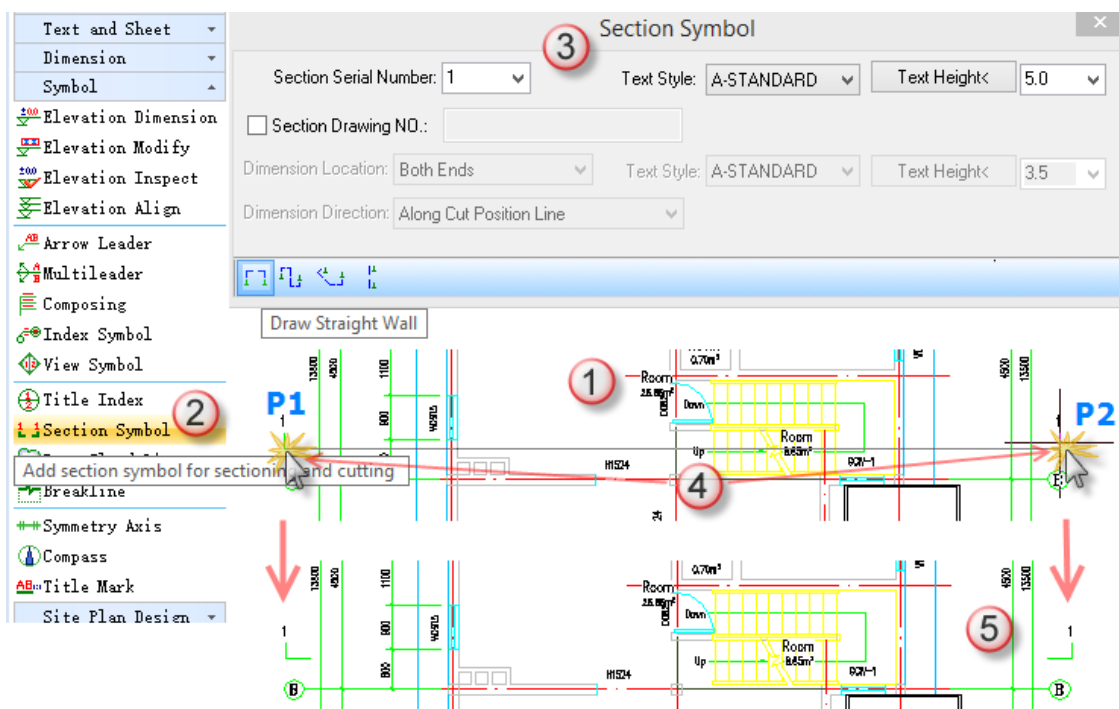

Fig 44. Operation Guide for Section Symbol

The dialog box is very simple, and you could try to modify parameters to experience many effects, including section line with turning.

5.19. Index Symbol Dimension

Objective: index symbol dimension in plan drawing.

Methods: Index Symbol Dimension command.

- (1) Move the drawing to an appropriate position;
- (2) Click Index Symbol Dimension command;
- (3) Set title index number to be "A16", index label to be "1", and index style to be pointing index;
- (4) Specify locating node point p1 for index region in drawing, and specify diameter of index region by p2, and then specify turning point p3, at last specify index tag position p4.
- (5) Finish index symbol dimensioning.

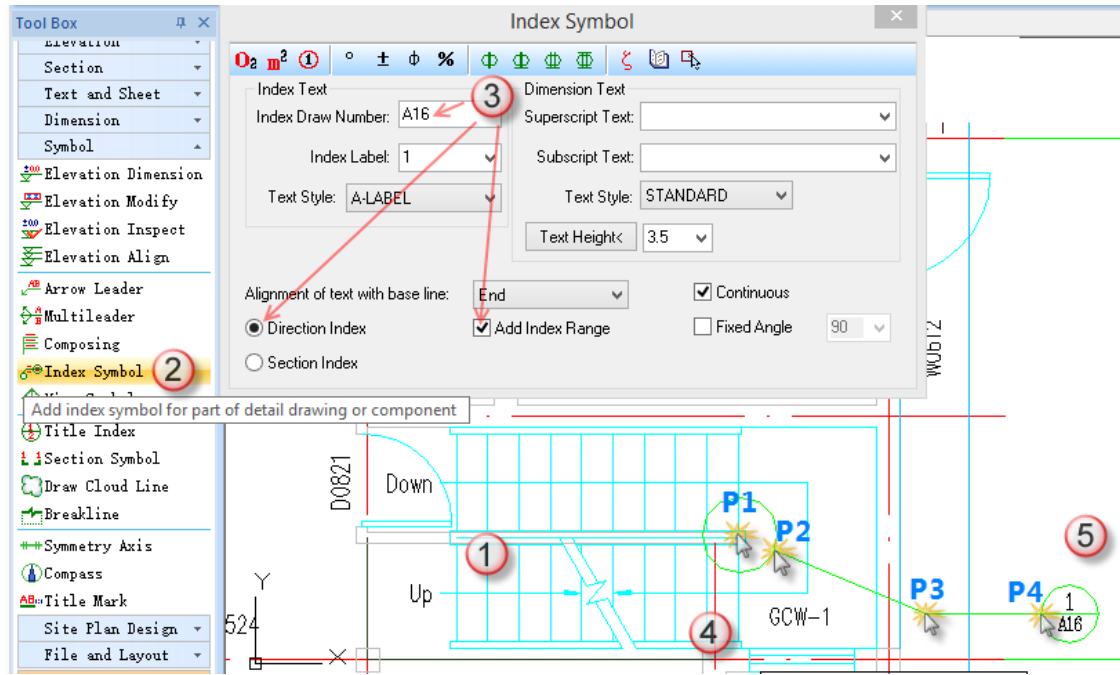

Fig 45. Operation Guide for Index Symbol

The dialog box is very simple, and you could try to modify parameters to experience different effects. The following are some index symbols styles; you could follow prompts to try.

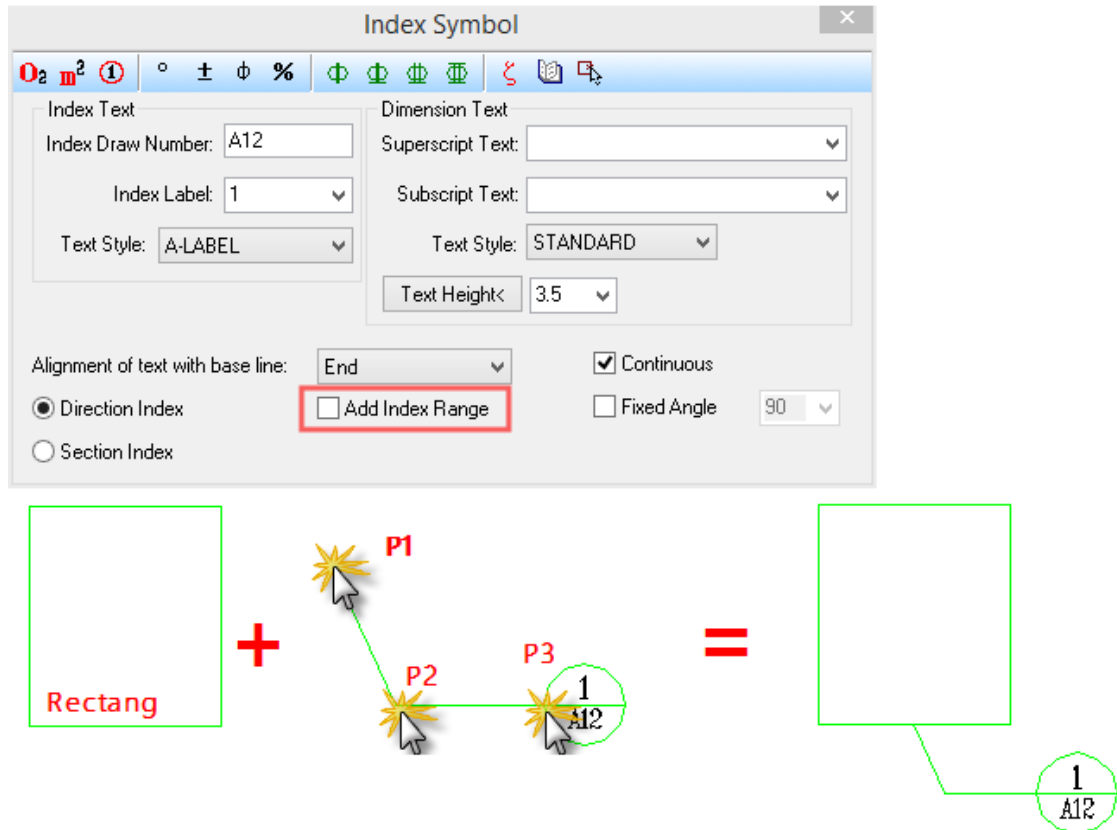

Fig 46. Style 1 for Index Symbol

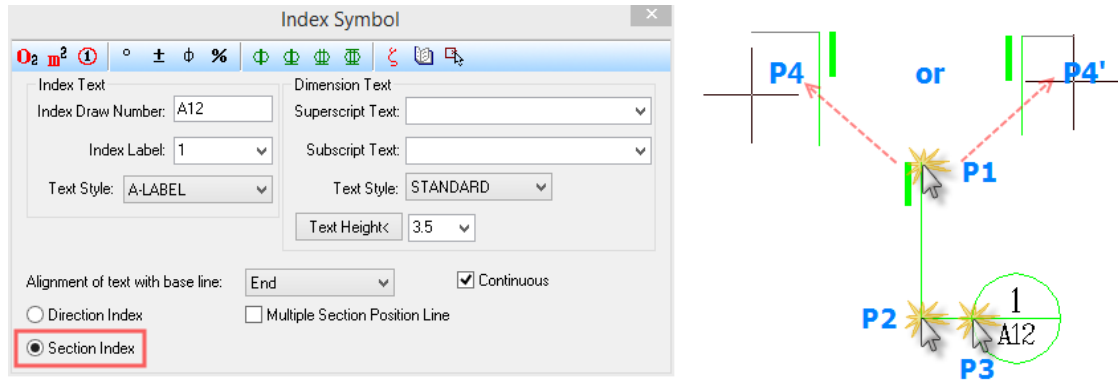

Fig 47. Style 2 for Index Symbol

5.20. Title Index Dimension

Objective: index title dimension in plan drawing.

Methods: Title Index command.

- (1) Click Title Index command;
- (2) Set title index to be "A12" in dialog box, and title index to be "1"; check scale factor, and select scale factor "1:20";
- (3) Click to locate Title Index.

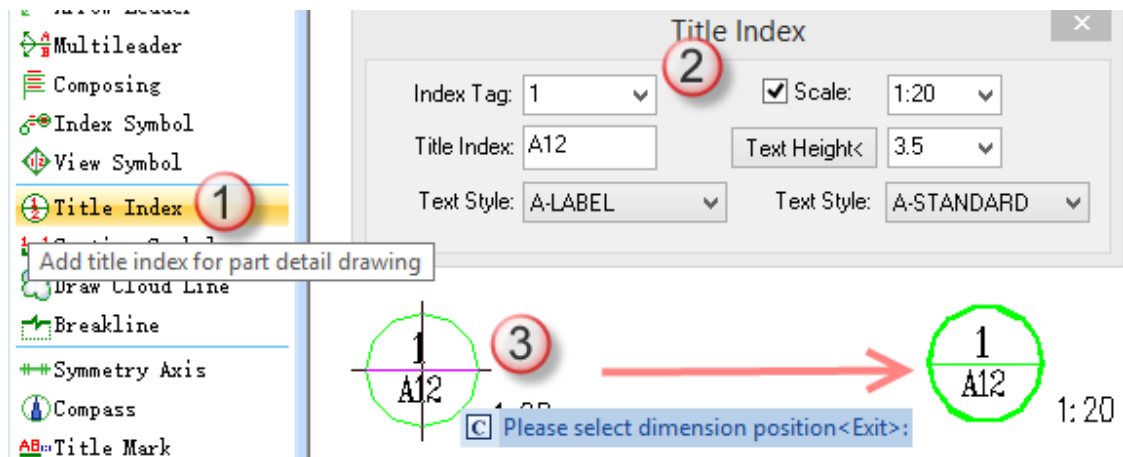

Fig 48. Operation Guide for Title Index

The dialog box is simple, and you could try to modify parameters to experience different effects.

5.21. Title Mark

Objective: title mark in plan drawing

Methods: Title Mark command

- (1) Click Title Mark command;
- (2) Set title name to be "Ground Floor", and select scale factor to be "1:50" in dialog box;

- (3) Click the position to locate Title Mark;

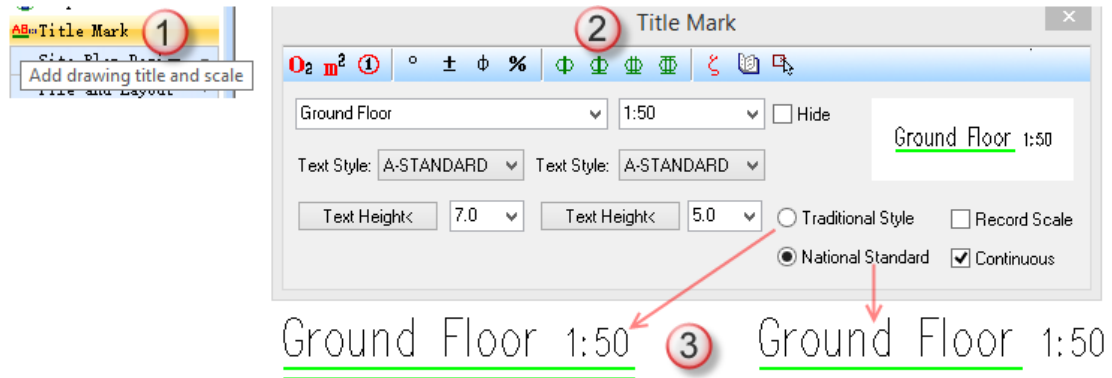

Fig 49. Operation Guide for Title Mark

5.22. Viewport Symbol

Objective: Viewport Symbol dimension in plan drawing.

Methods: Viewport Symbol command.

- (1) Click Viewport Symbol command;
- (2) In dialog box, set viewport index number to be "1", and set title tag to be "E12"; check fixed angle and value is "45" degrees;
- (3) Click the position to locate viewport symbol;
- (4) Finish viewport symbol dimension.

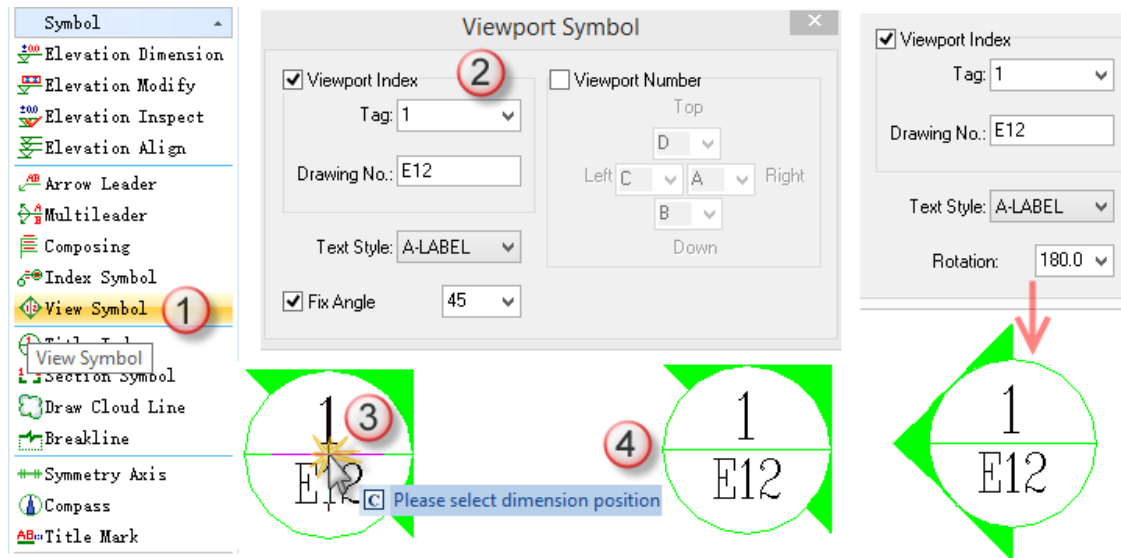

Fig 50. Operation Guide for Viewport Symbol

The dialog box is simple, and you could try to modify parameters to experience different effects.

5.23. Compass

Objective: draw compass on plan drawing.

Methods: Draw Compass command.

- (1) Click Draw Compass command;
- (2) Specify a point in drawing to locate compass center point;
- (3) Specify compass included angle according to command prompts or specify compass direction by clicking in drawing.

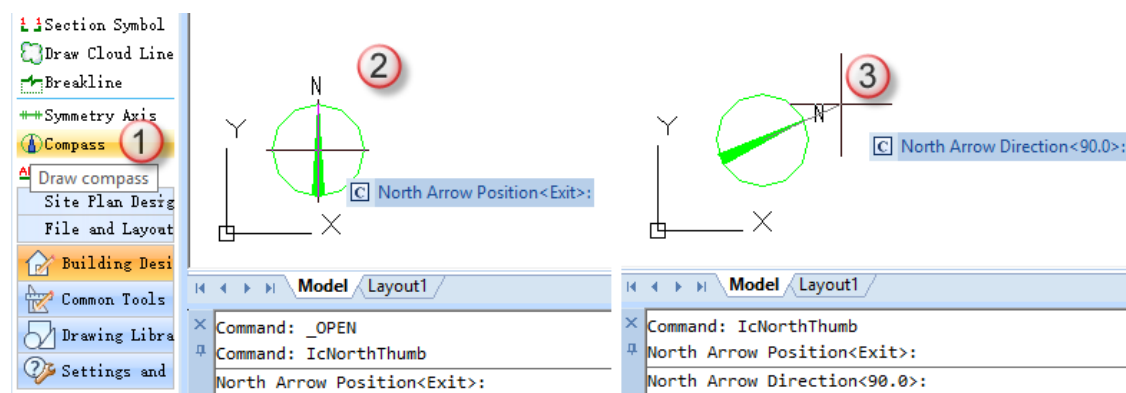

Fig 51. Operation Guide for Drawing Compass

5.24. Stage exercise Summary and Drawing Process

Objective:

1. Familiar with the operation of the previous commands;
2. Complete second and third floor plan drawing work, preparing for underlay the next phase.

Methods: use previous commands and complete drawing the Basement floor, First floor, and so on, shown as below.

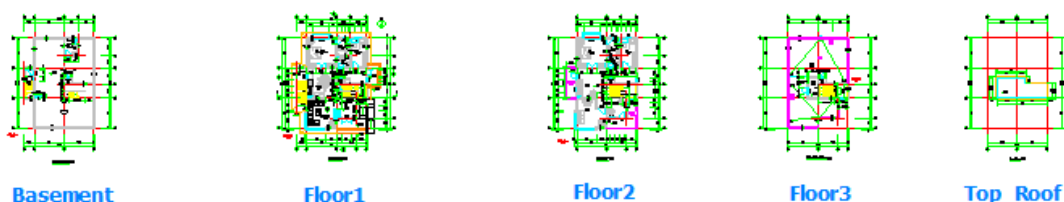

Fig 52. Plan drawings for all floors

All drawings for different floors are put together in one DWG file.

5.25. Project Management

Objective: build model based on all drawings for different floors.

Methods: Project Management command.

You could build 3D models, and generate elevation drawings (2D) and section drawings (2D) by all floors of drawings. The 3D model could be combined by Project Management function.

- (1) Click Project Management command. It displays a dialog box as below:

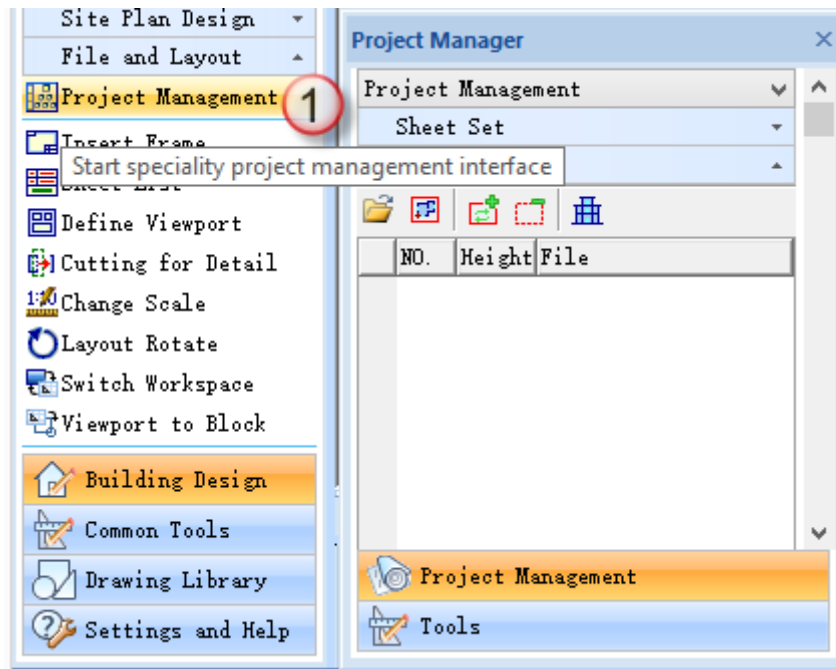

Fig 53. Operation Guide 1 for Project Management

- (2) Click New Project in pull-down menu and display a new dialog box;
- (3) Enter name as "project-1" and keep other options to be default. Click Ok to finish.
- (4) New project status: you could find "project1" file folder in specified position, and there exists a named "project-1.ipj" Project Management file. It means the project is created successfully. You could open previously existed project by clicking its ".ipj" file, through Open Project command under Project Management menu.

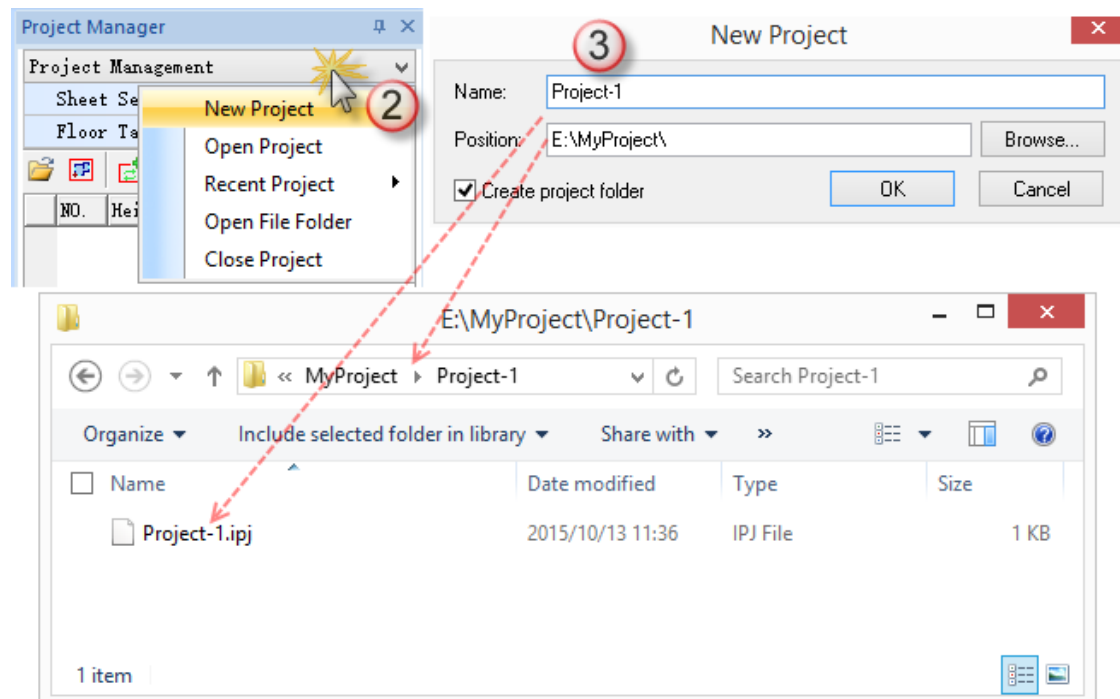

Fig 54. Operation Guide 2 for Project Management

- (5) Save the plan drawing to specified file folder, we could name it "plan.dwg" for example.

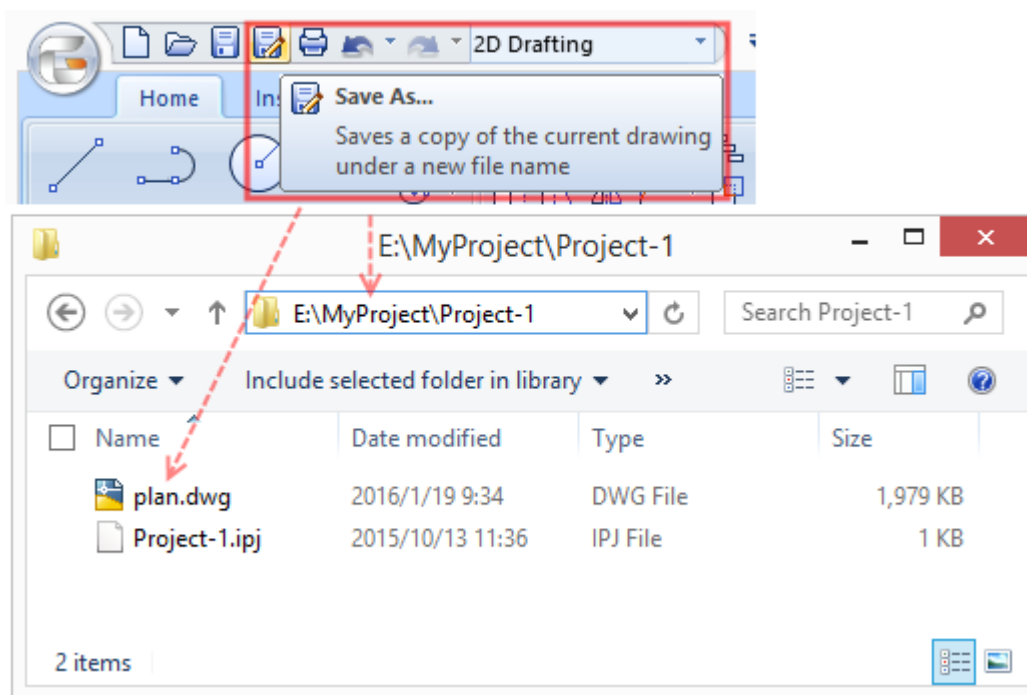

Fig 55. Operation Guide 3 for Project Management

- (6) Return to Project Management dialog box; click Floor Table menu, enter "1" for floor tag and enter "3000" (mm) for floor height, it means the height of first floor is 3000 mm. Note: floor height is different from objects height of floor (such as wall height, or column height). In general, floor height should be the same as objects height, which is very import for elevation and section drawing.

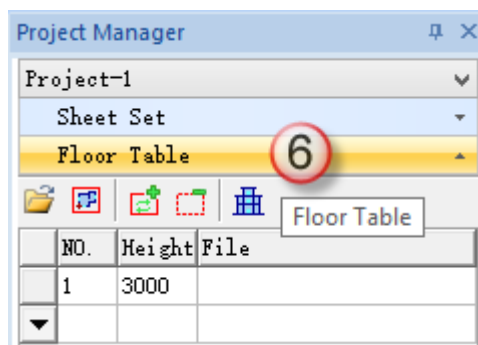

Fig 56. Operation Guide 4 for Project Management

- (7) Confirm that current floor is the first floor. Click Box Select Floors and then box select the plan region of ground floor according to command prompts; specify Base point of floors for alignment(base points for other floors should be at the same position in their specified region).

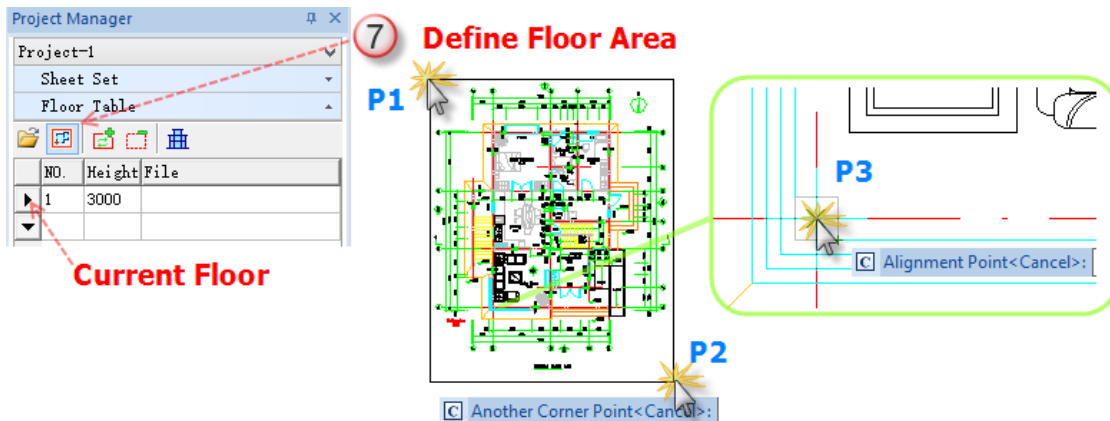

Fig 57. Operation Guide 5 for Project Management

- (8) Now the drawing region and content are determined. In the Project Management dialog box, it prompts that the content of first floor is "plan< box selection>". You could view current box selected region and alignment point by clicking Show and Refresh Define Frame of floor button. If there is something wrong, you could repeat step 7. The floor frame could be hidden by clicking Hide Define Frame of floor button.

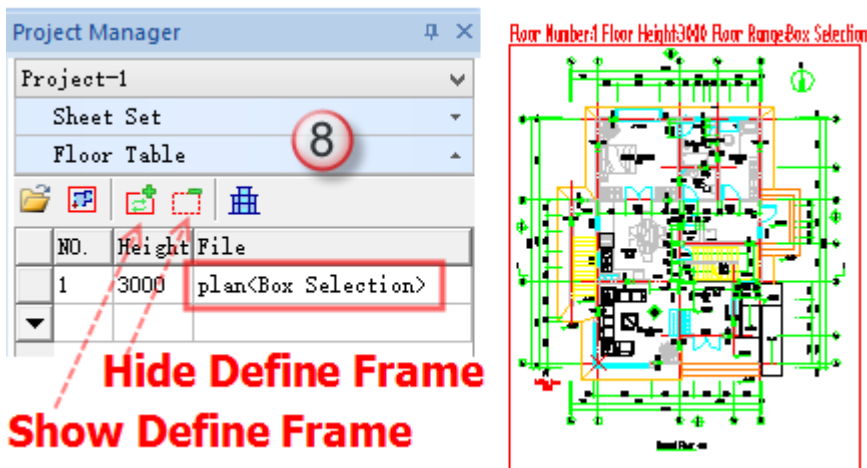

Fig 58. Operation Guide 6 for Project Management

- (9) Complete definition of floors (from first floor to forth floor) by repeating steps (from step 6 to step 8).

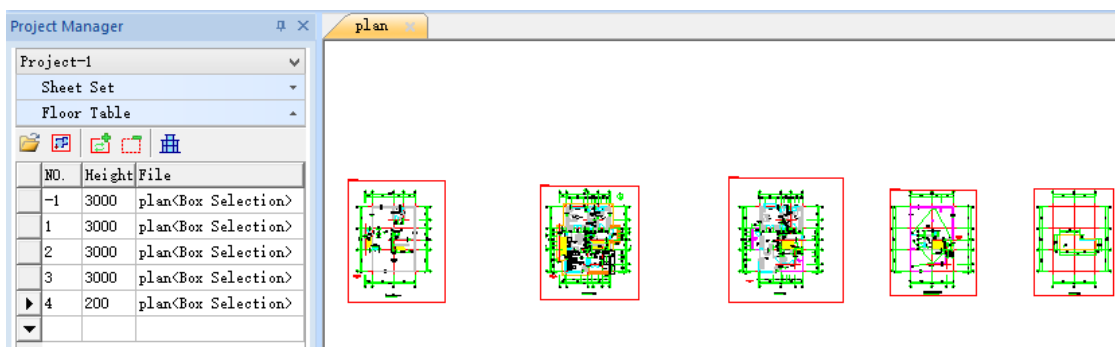

Fig 59. Operation Guide 7 for Project Management

After settings of Project Management, you could generate elevation, section, and 3D model.

5.26. Generate Elevations by Project Management

Objective: generate elevation by model that built by all drawings of each floors.

Methods: Building Elevation command.

- (1) Make sure that the project management documents have established and all floor relationships are correct. Open project management file.
- (2) Click Building Elevation command and pay attention to command prompts;
- (3) Enter F according to command prompts to generate building elevation in front view;
- (4) Box select axis line according to command prompts and pay attention to the positions of p1 and p2;
- (5) In this sample we selected four axes from number 1 to number 4, and press enter to next step.

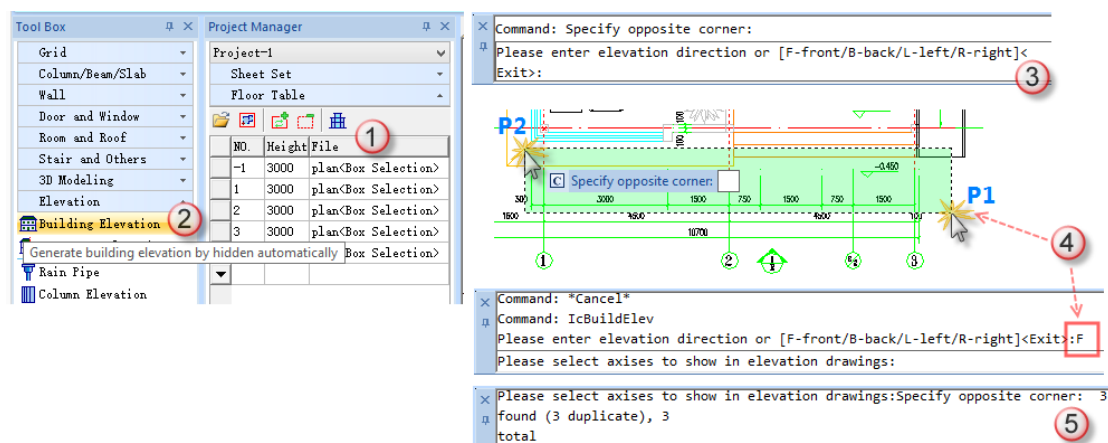

Fig 60. Operation Guide 1 for Elevation

- (6) Click Generate Elevation button without modifying other parameters in dialog box

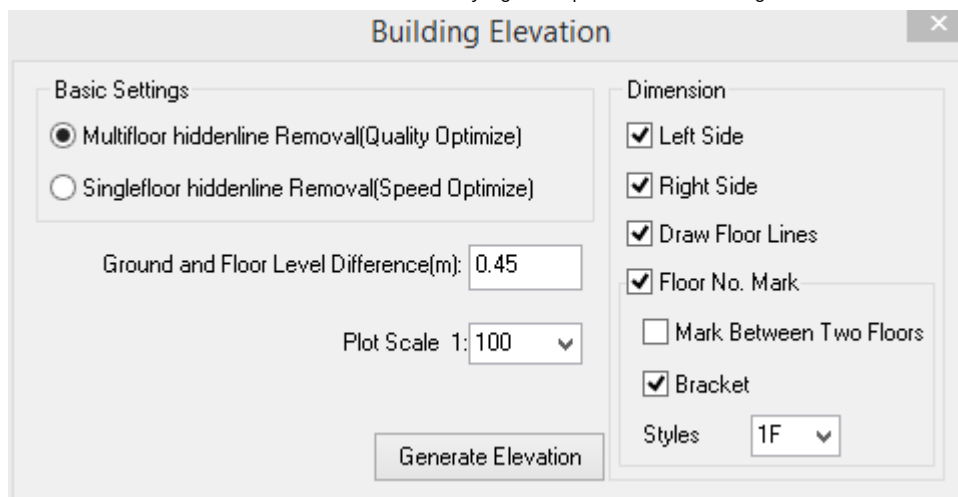

Fig 61. Operation Guide 2 for Elevation

- (7) The generated elevation will be saved as a new file, click Save button to continue.

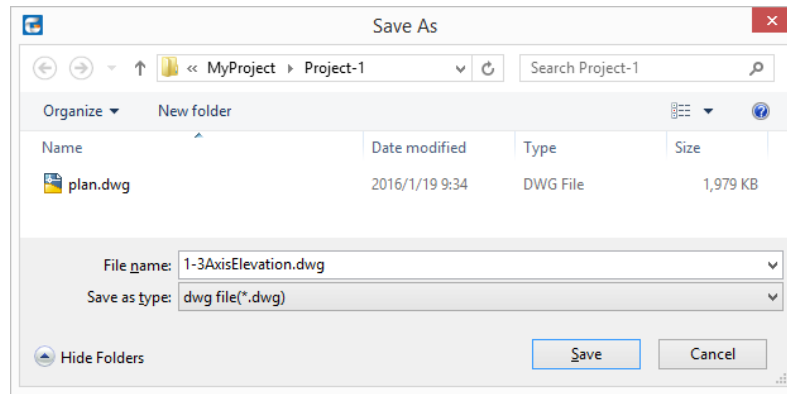

Fig 62. Operation Guide 3 for Elevation

- (8) The generated elevation will be opened and displays as below (2D drawing):

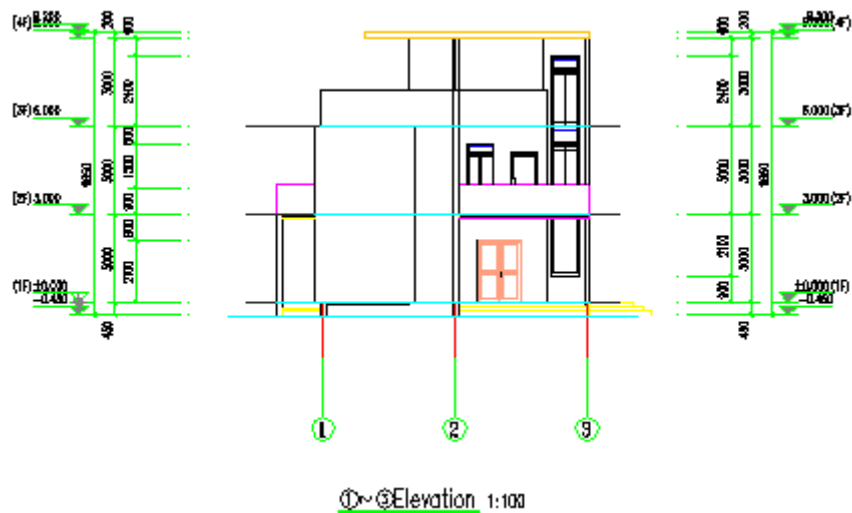

Fig 63. Operation Guide 4 for Elevation

5.27. Generate Section by Project Management

Objective: generate section by model that built by all drawings of each floors

Methods: Building Section command

- (1) Make sure that the project management documents have established and all floor relationships are correct. Open project management file;
- (2) Click Building Section command and pay attention to command prompts;
- (3) Select existed section line in drawing;
- (4) Box select axis line according to command prompts and pay attention to the positions of p1 and p2;

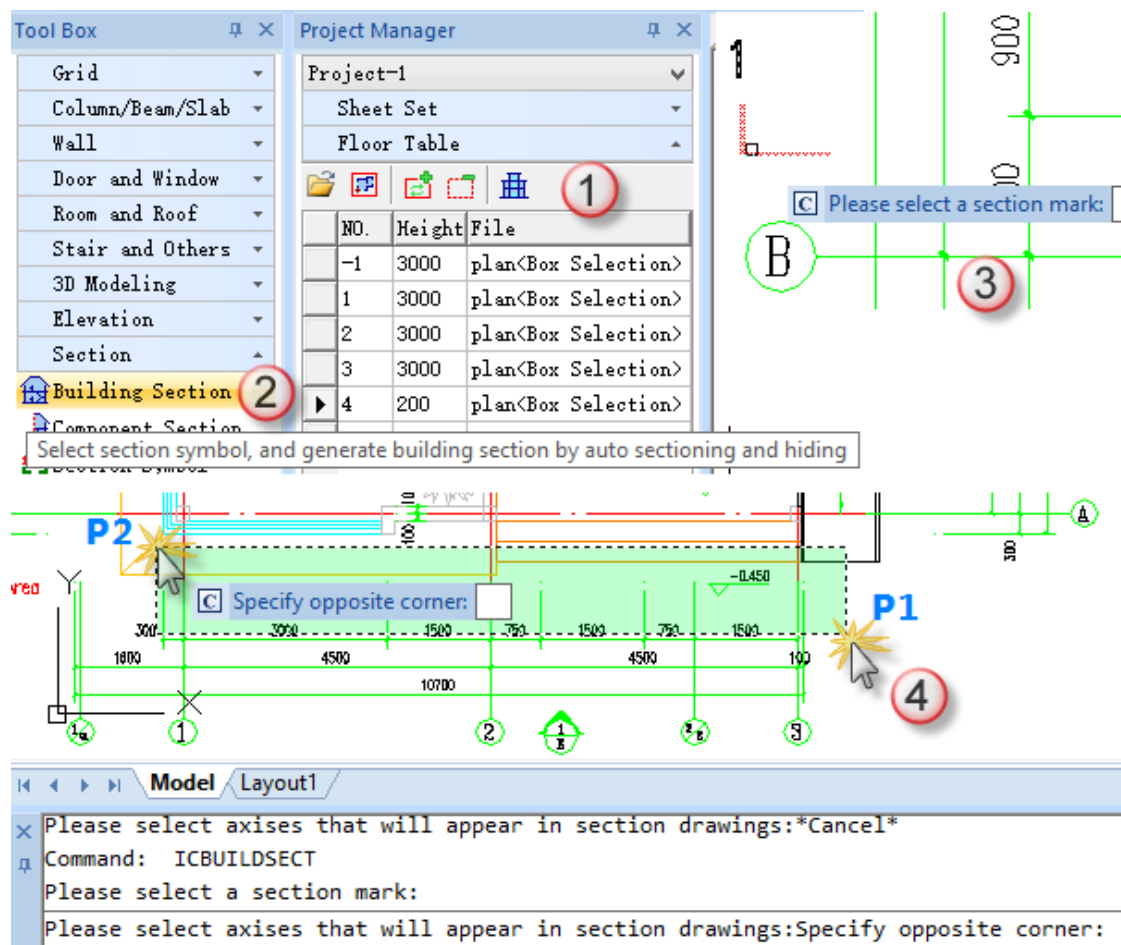

Fig 64. Operation Guide 1 for Section

- (5) Press Enter key after selecting axis, and then click Generate Section button in pop-up dialog box.

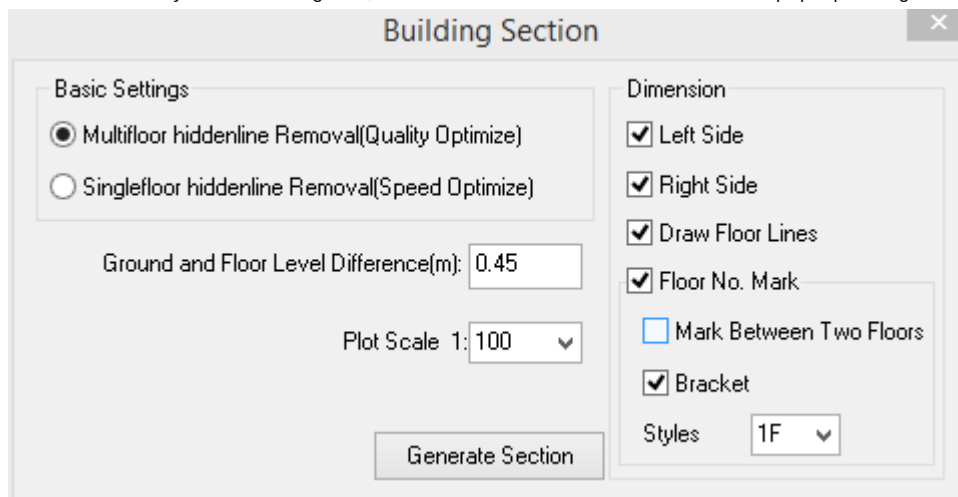

Fig 65. Operation Guide 2 for Section

- (6) The generated section will be saved as a new file, click Save button to continue.

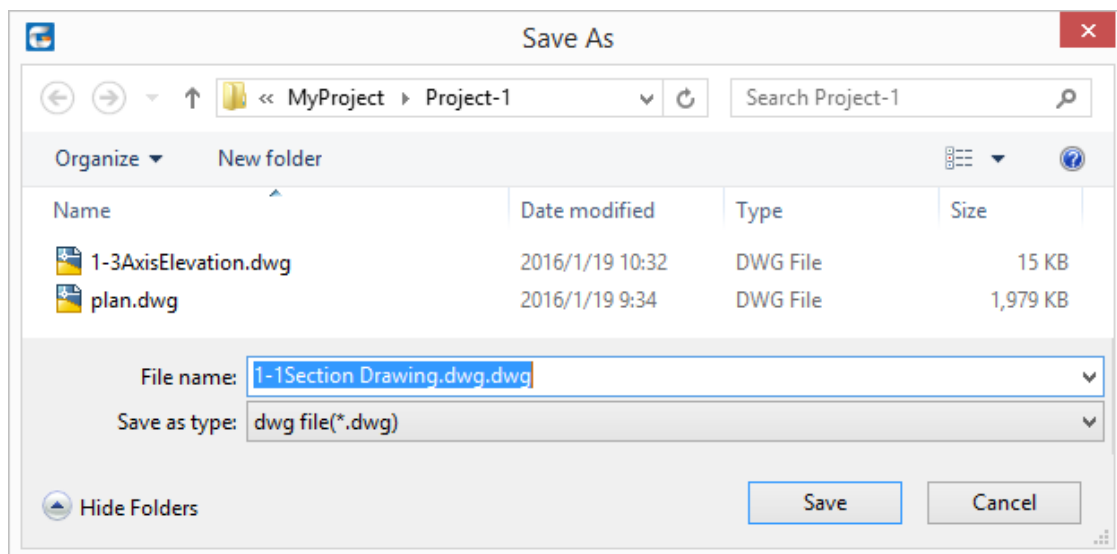
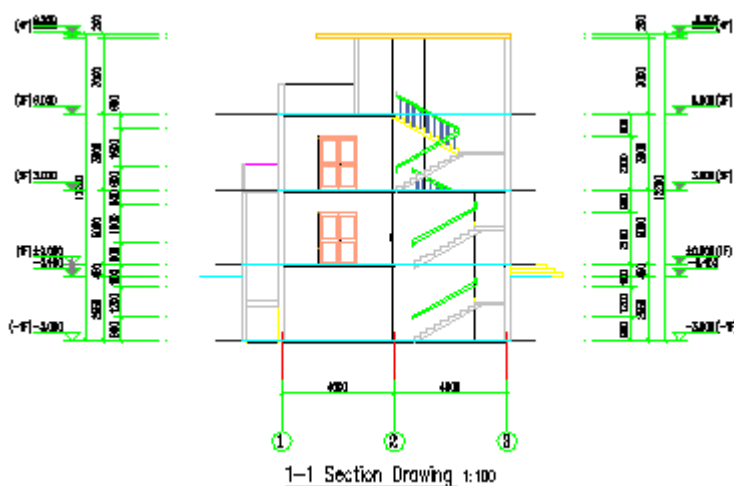

Fig 66. Operation Guide 3 for Section

- (7) The generated section will be opened and displays as below (2D drawing):



- (3) Check Drag to Current Drawing option and click Ok;
- (4) Specify one point in drawing to place the 3D building model according to command prompts. The current viewport is a plan mode, rather than view of all aspects.

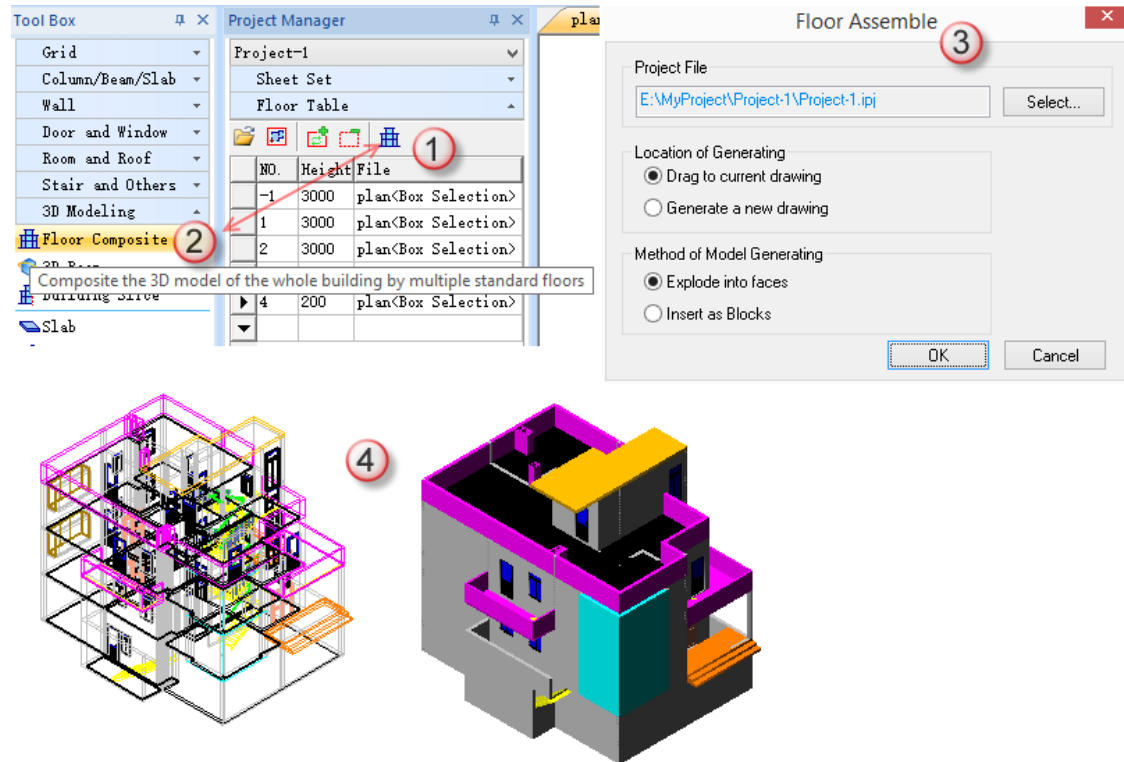

Fig 68. Operation Guide for 3D model

- (5) Right click in drawing area and pop-up right click menu, and then select SE Isometric view in the menu. Now the model displays its 3D isometric view in drawing.

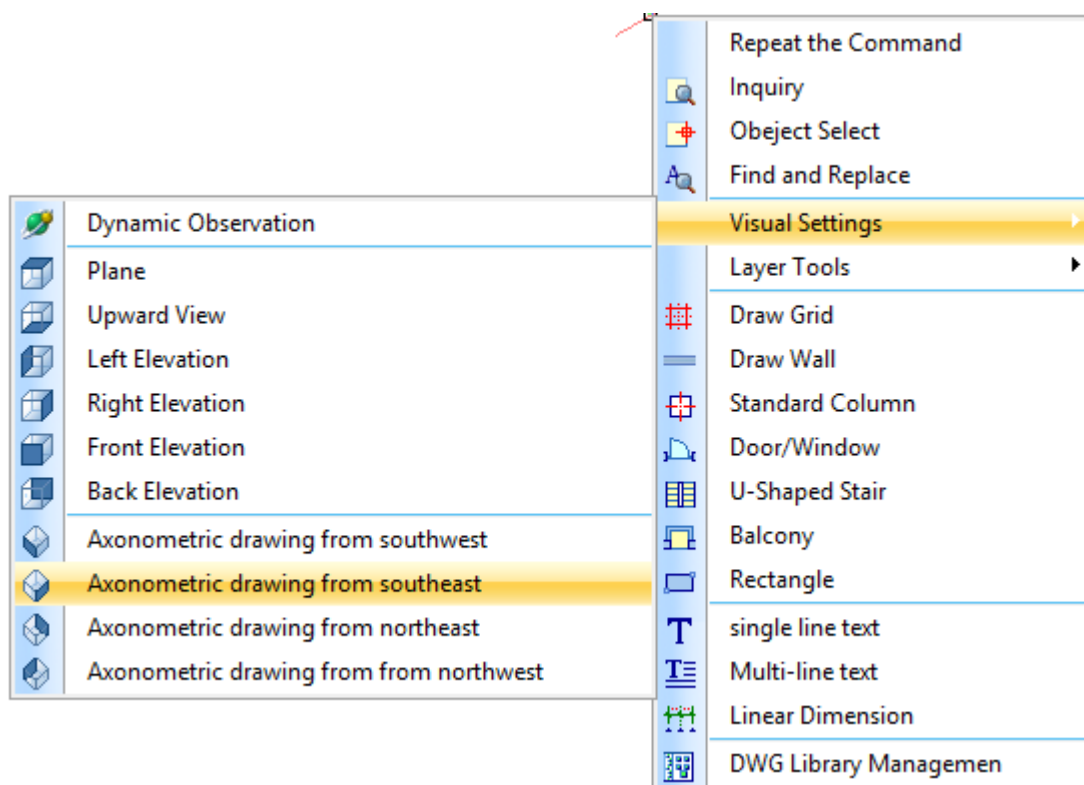

Fig 69. Visual Settings

The generated DWG 3D model could be imported to some 3D softwares, such as sketchup, and it could be edited and processed by them.

5.29. Summary

Through above cases, we have a certain understanding about professional drawing and modifying function provided by GCA; and we are familiar with Dimension, Symbols, and other operations; as well we know clearly the important role of Project Management played.

GCA provides many practical tools; you could access www.gstarcad.net for more related information.